

“5803”

versionsnummer: 18.05.2026

Naturholz kann sich werkstoffbedingt verziehen. Durch das Montieren ziehen sich Teile wieder plan.

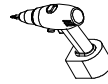
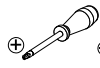
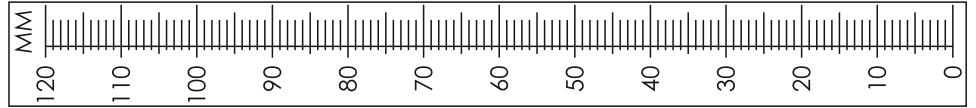
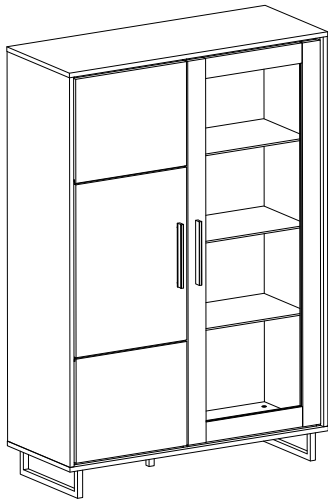

60 min

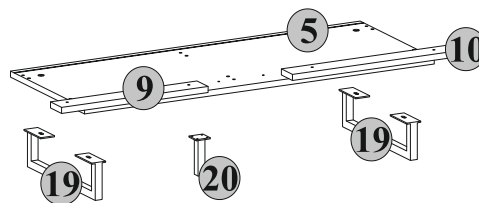
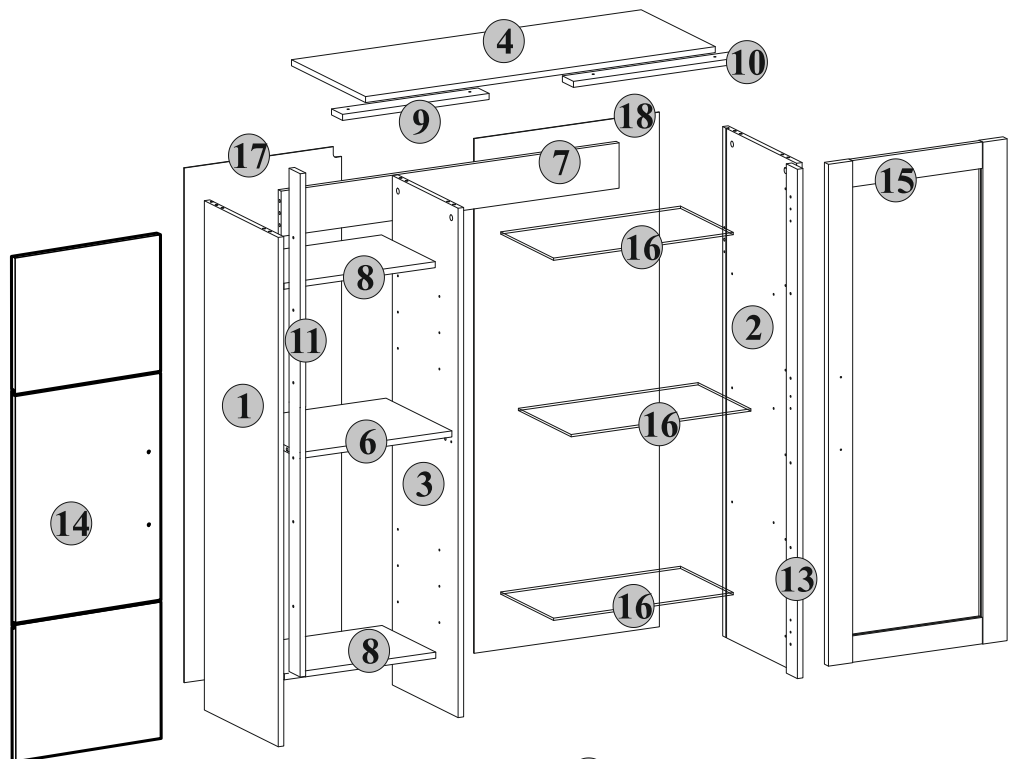
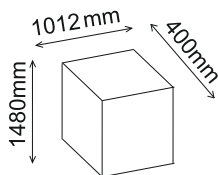

B5

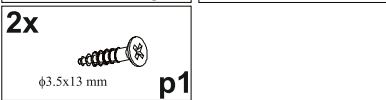
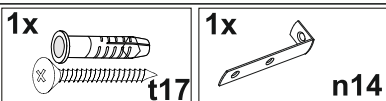

B1

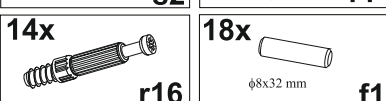
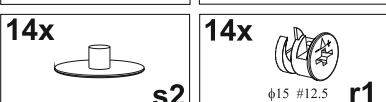
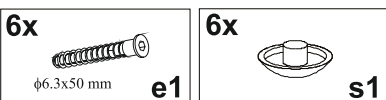

B2

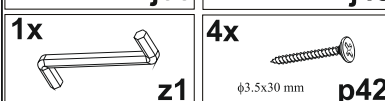
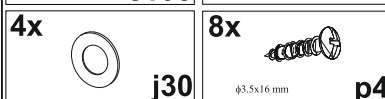
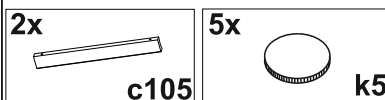

B3

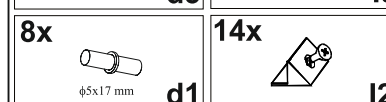
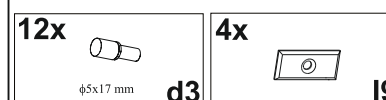

B4

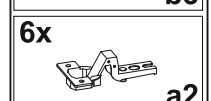
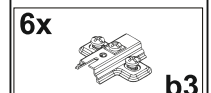

I

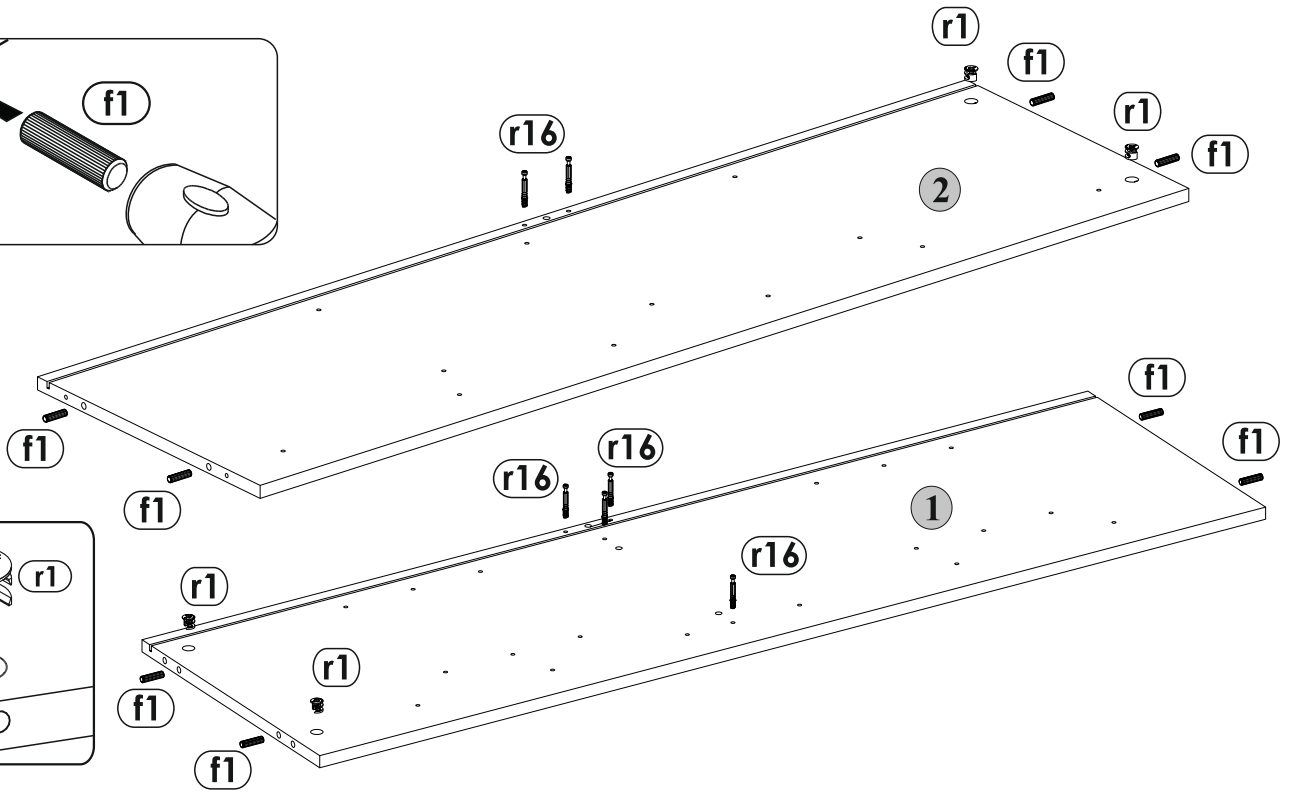
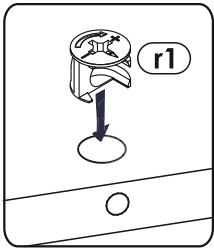
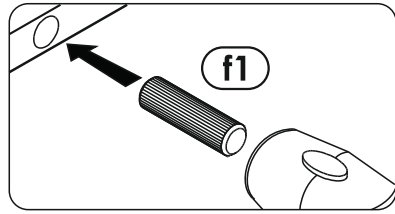
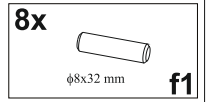
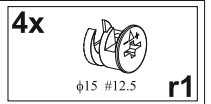
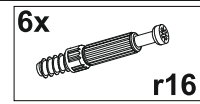
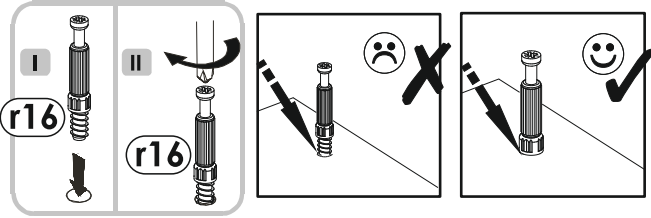

2

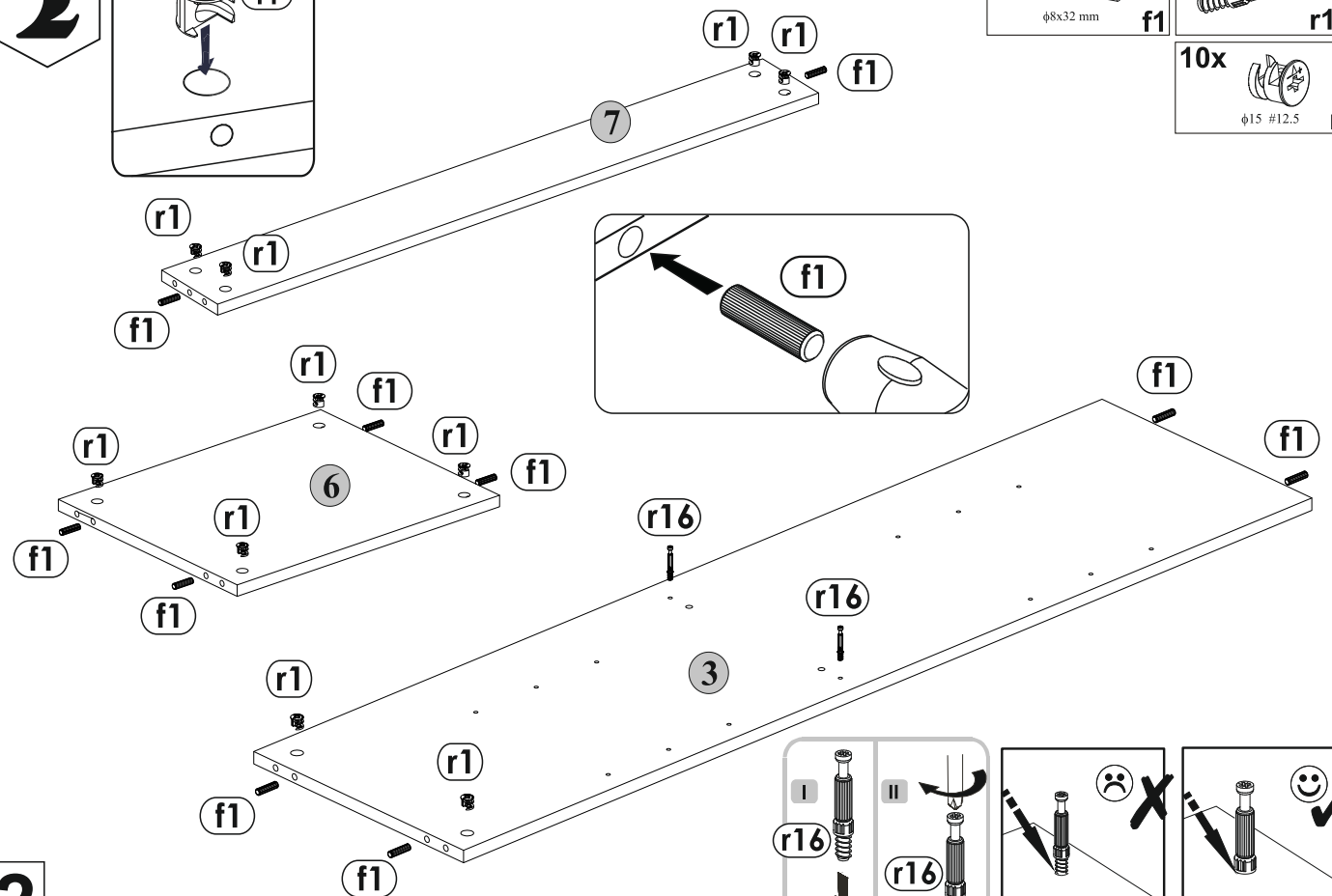
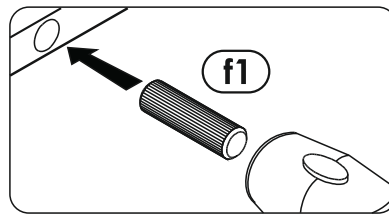
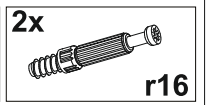
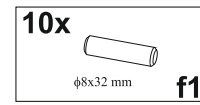
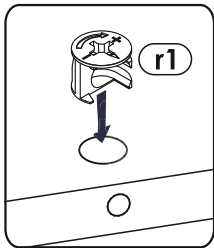

2

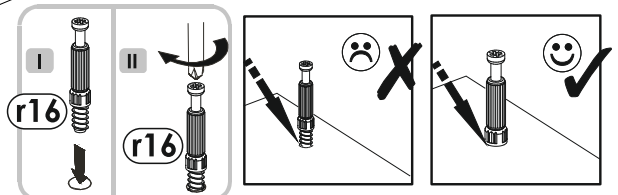

3

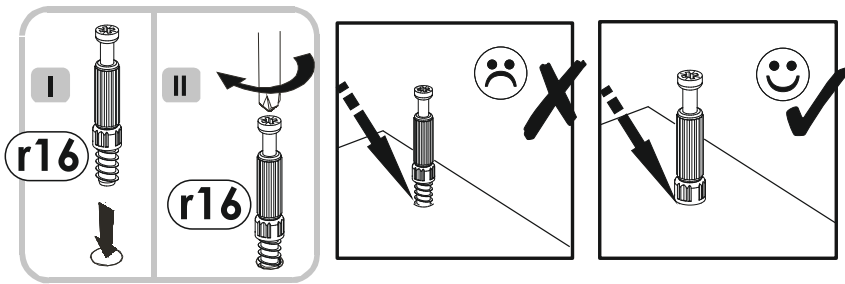

6x
r16

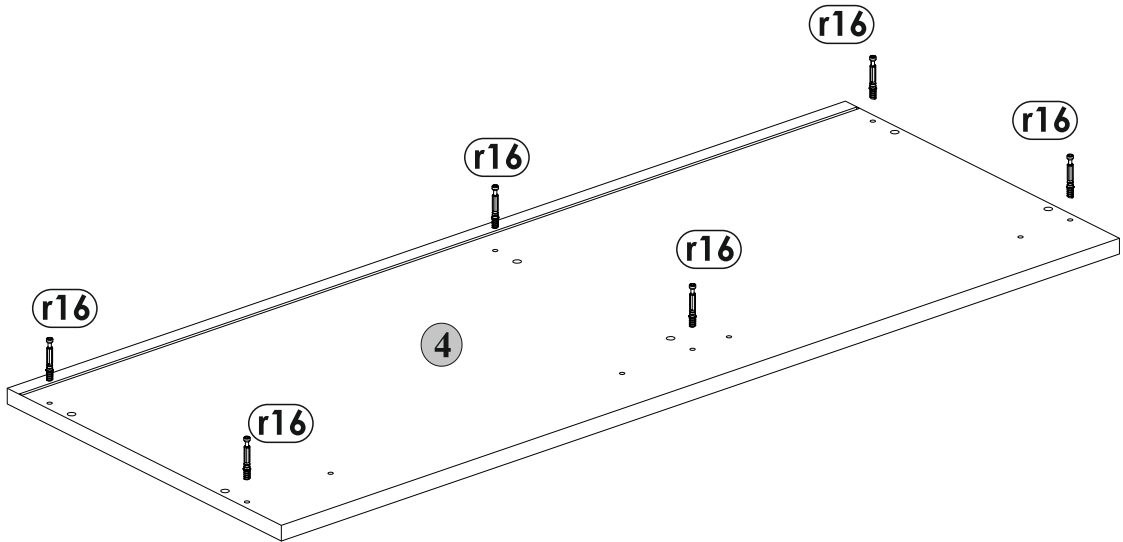

4

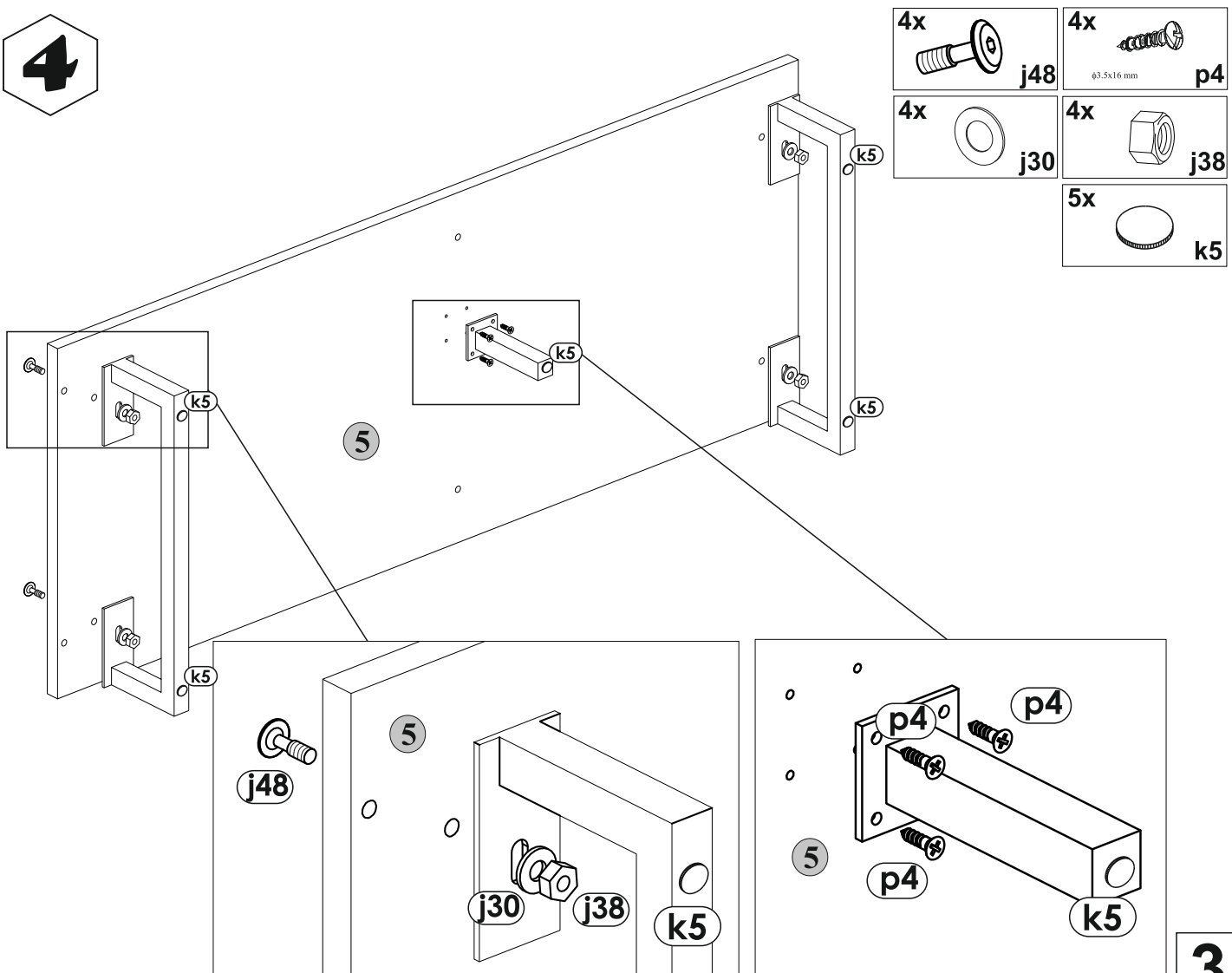

3

5

6x  b3

12x  e2
φ6.3x13 mm

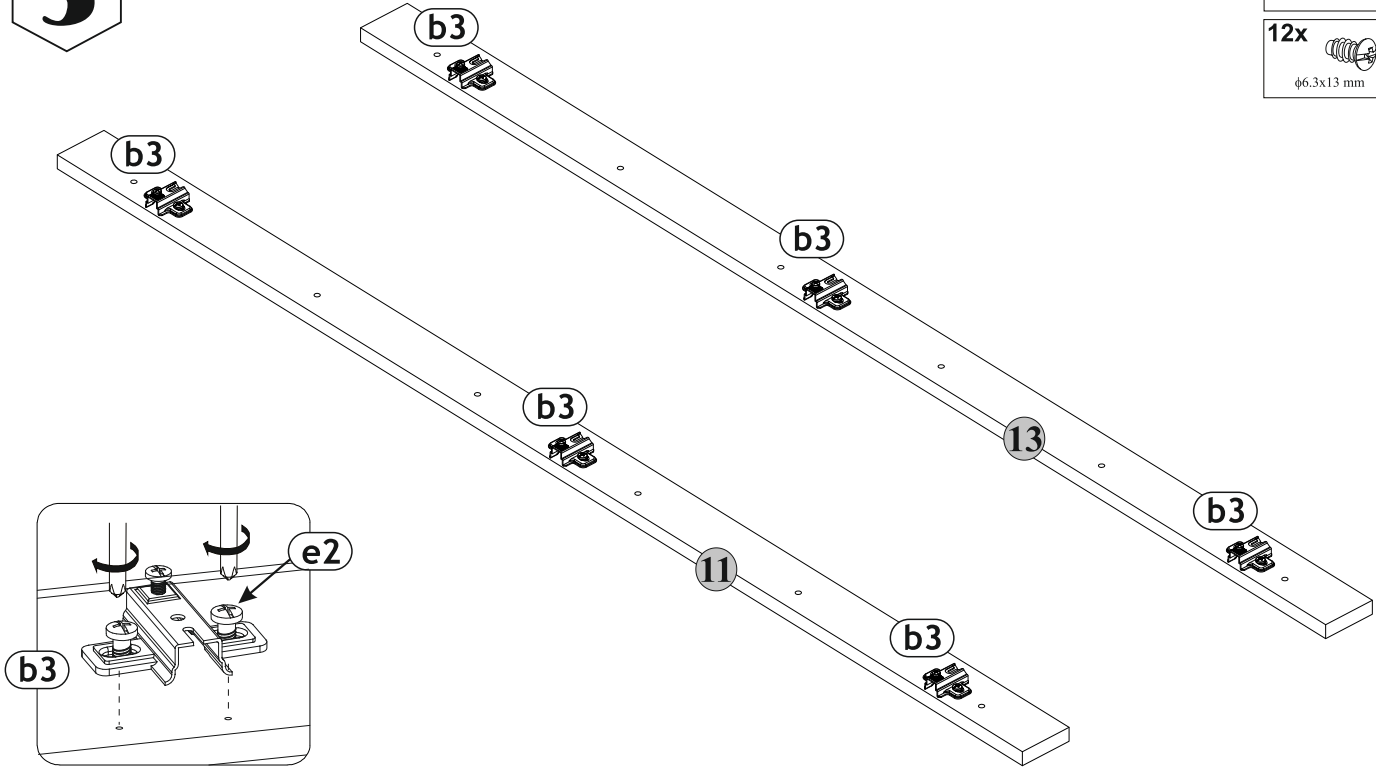

6

6x  a2

12x  p1
φ3.5x16 mm

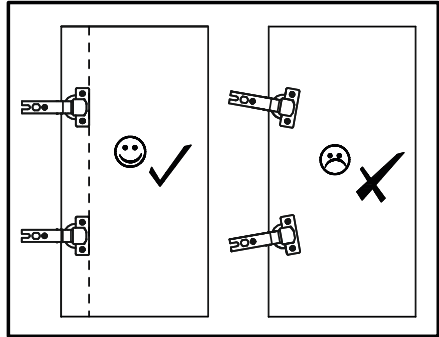
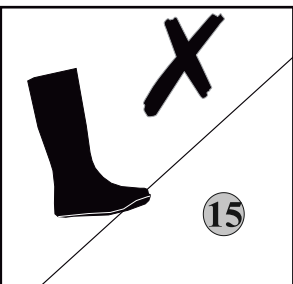
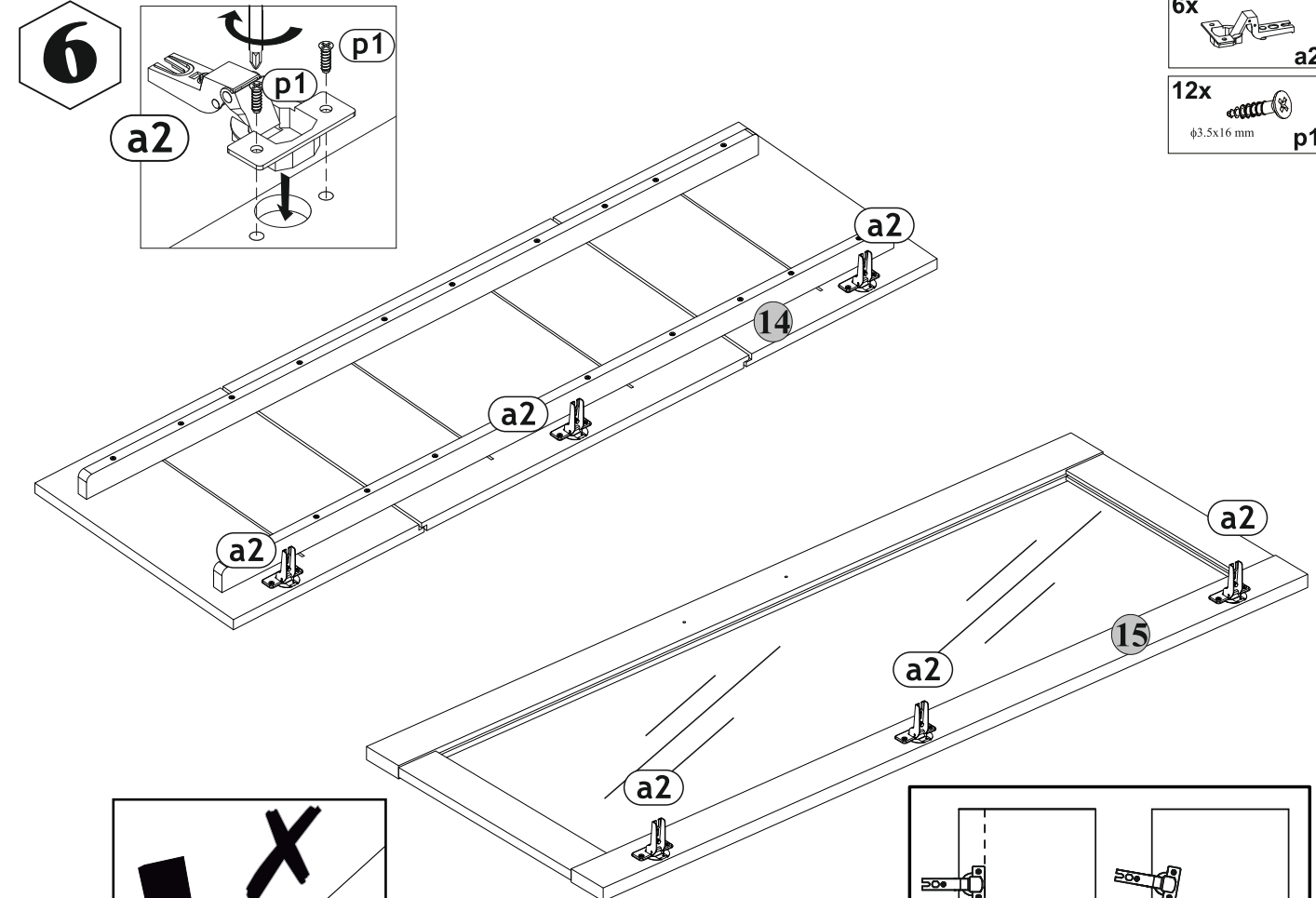

4

7

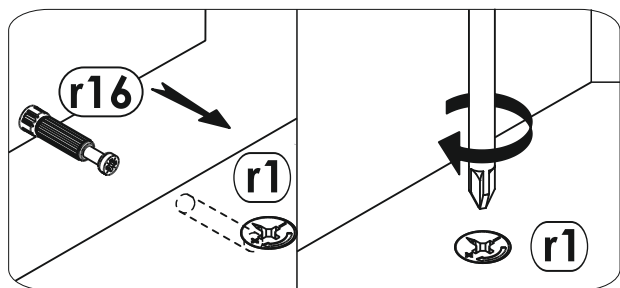
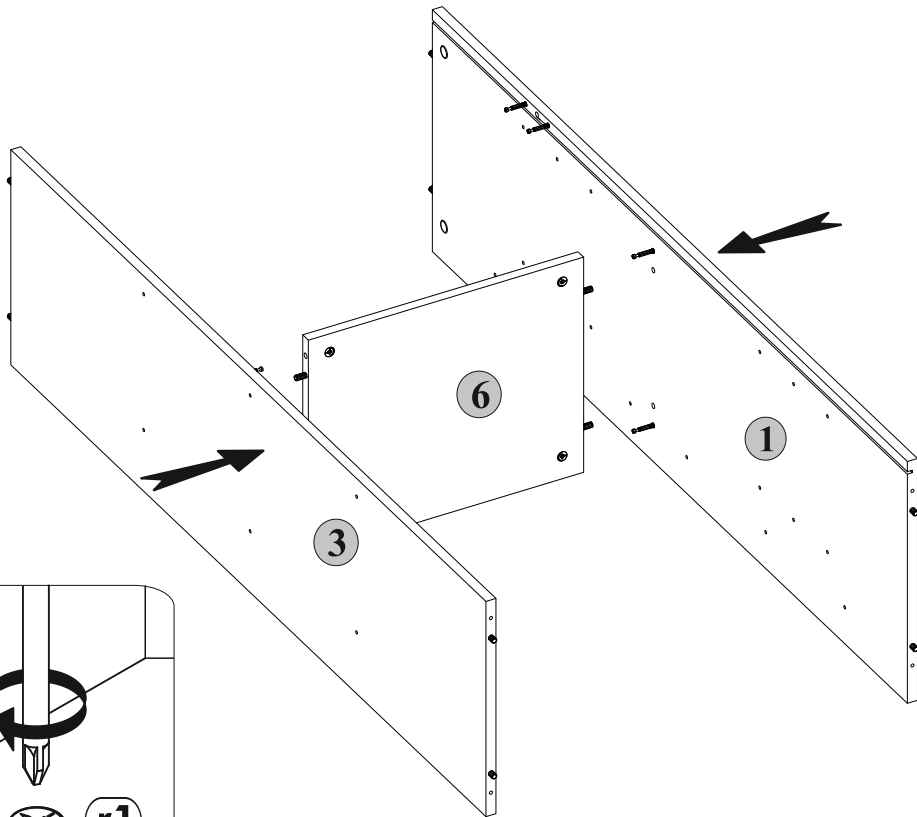

8

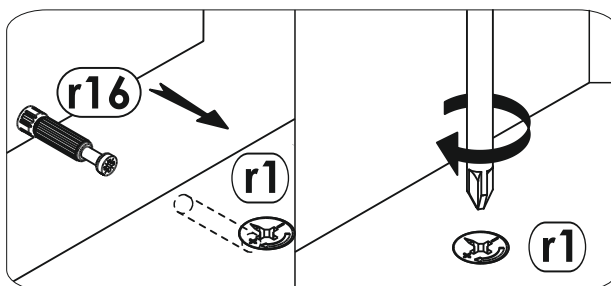
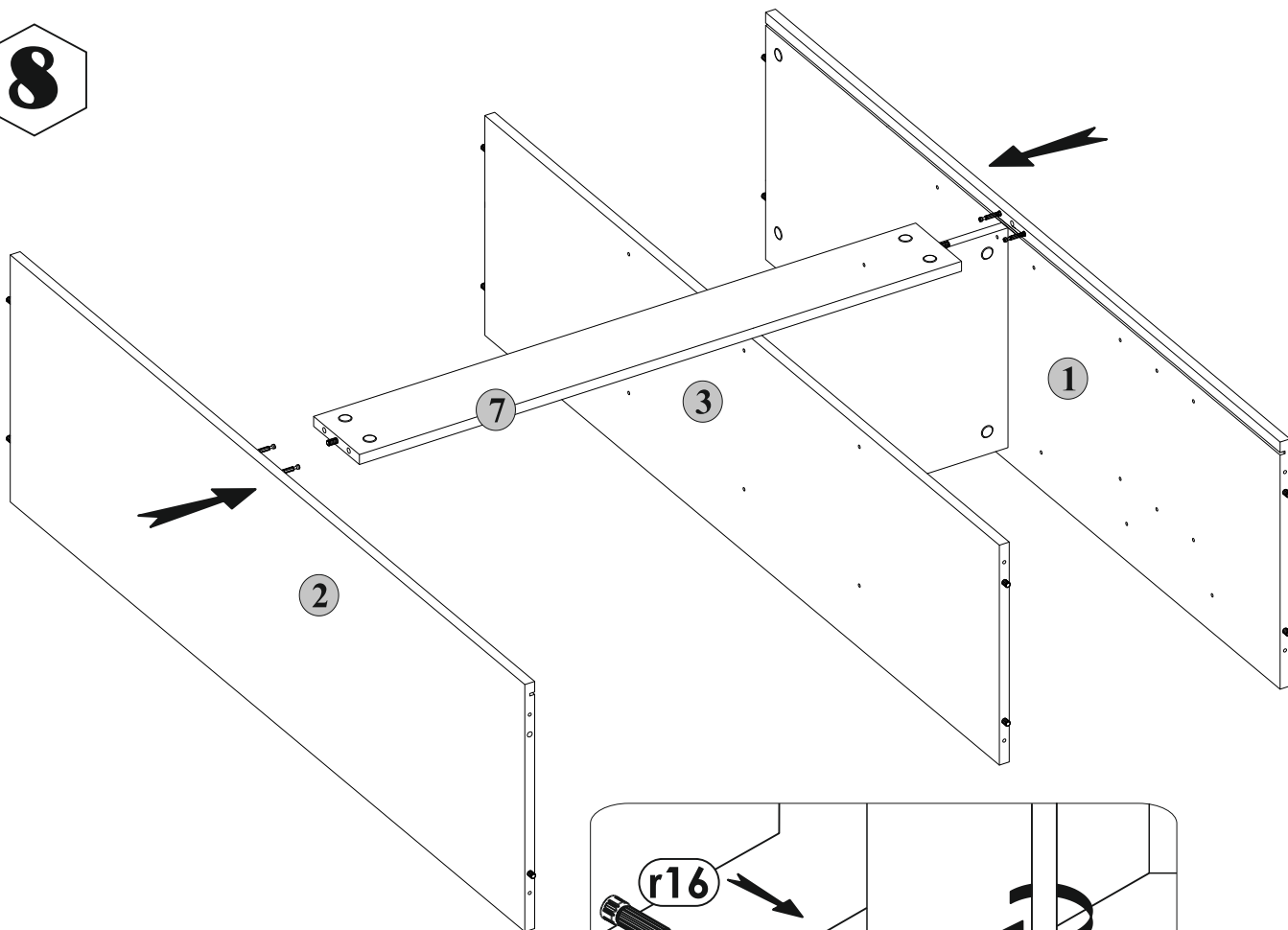

5

9

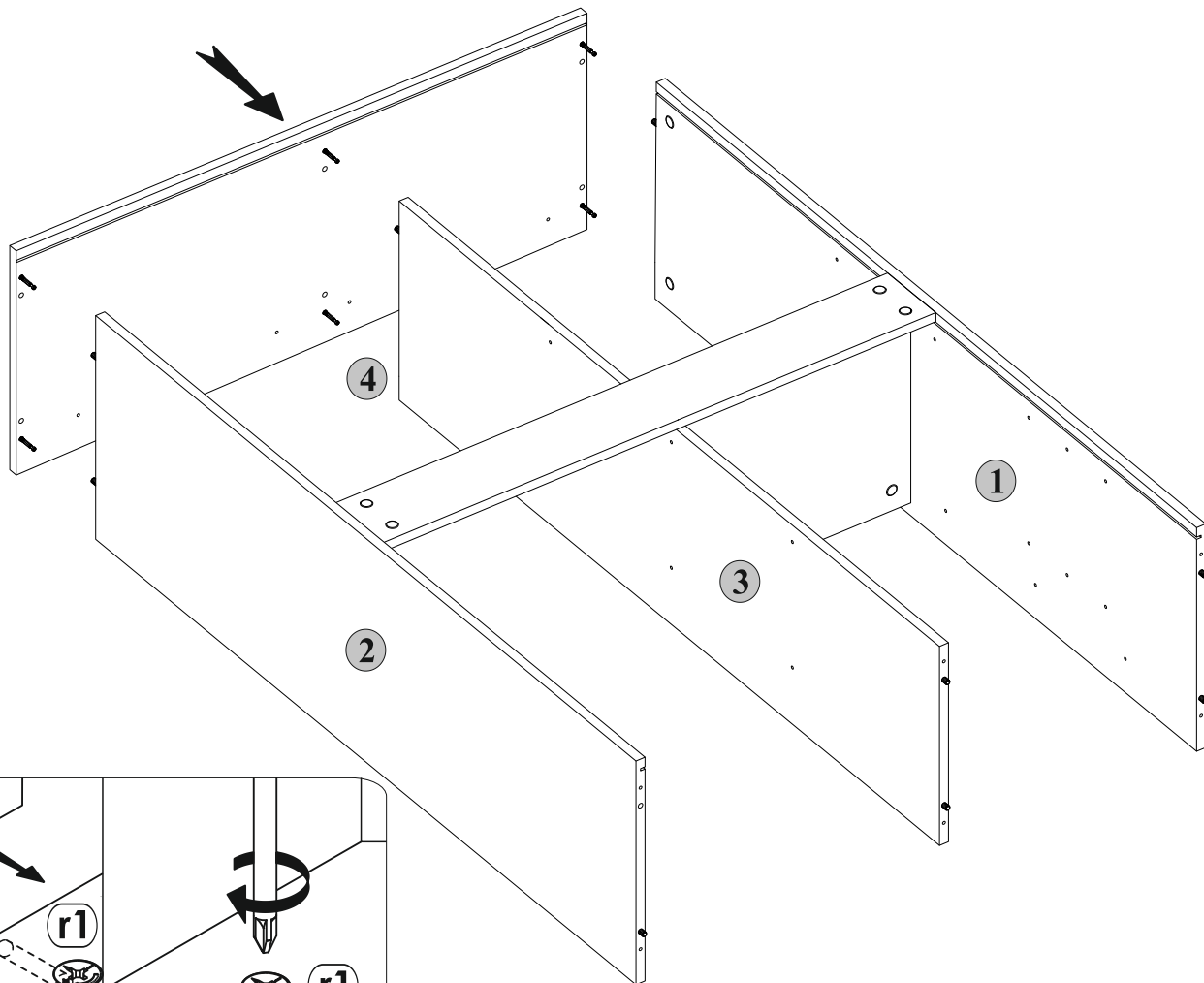

10

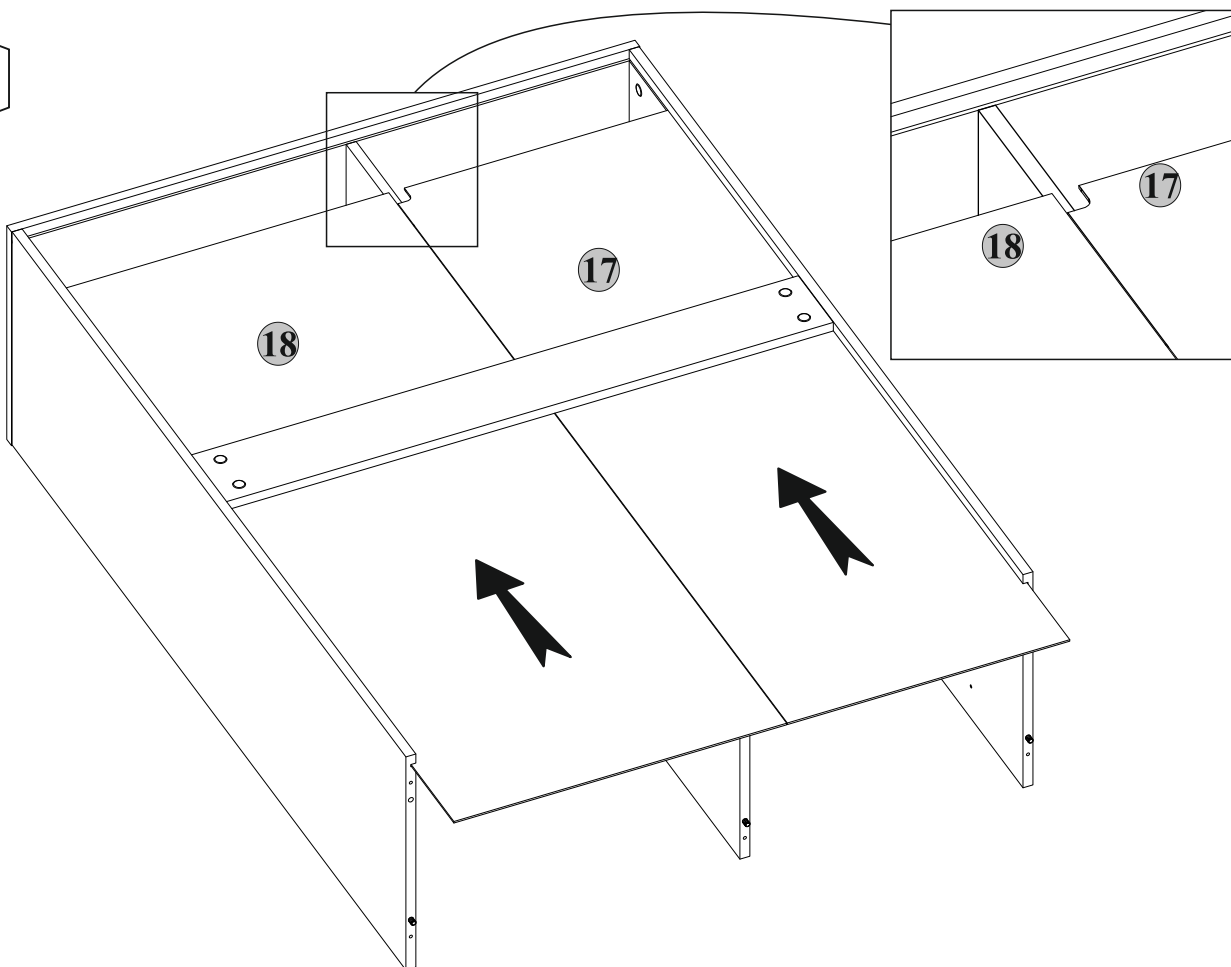

6

11

6x
e1

6x
s1

1x
z1

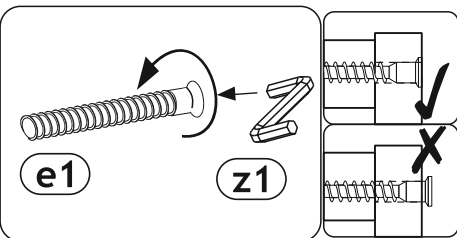
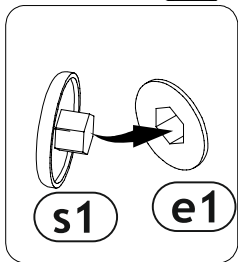
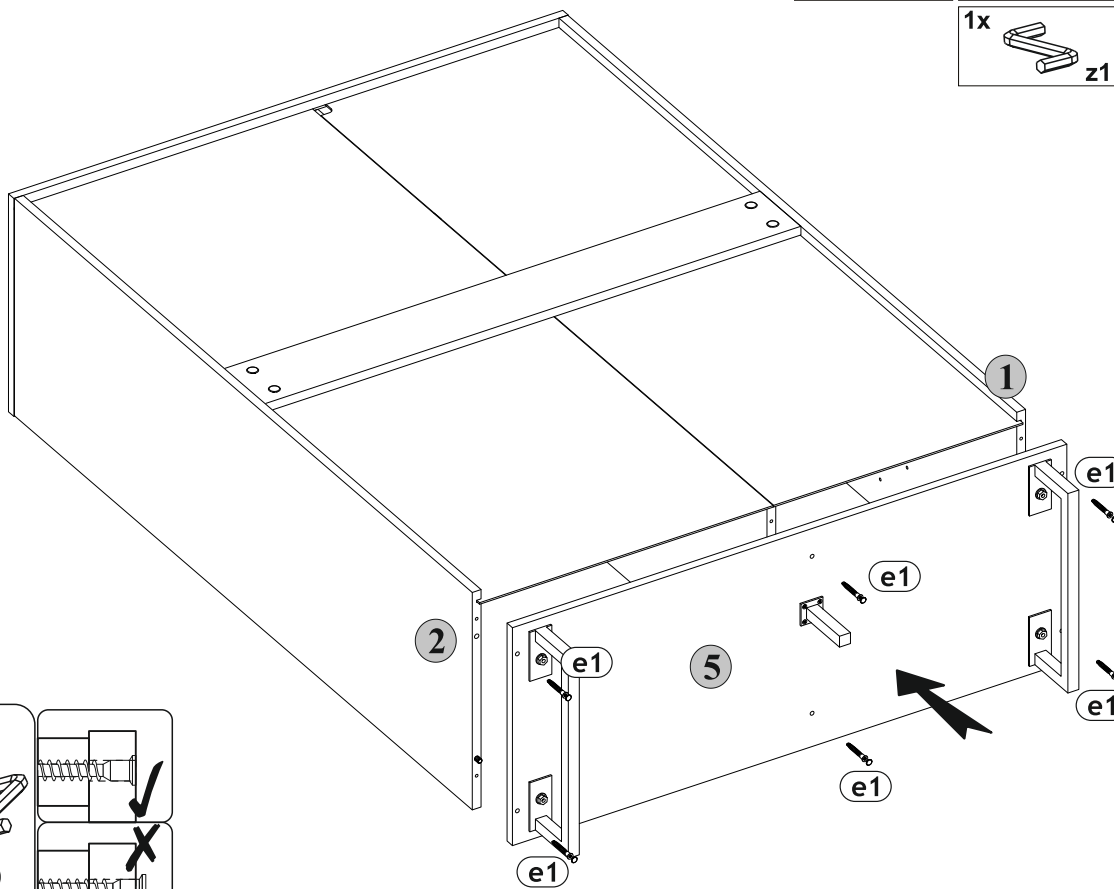

12

14x
l2

4x
l9

4x
p4
φ3.5x16 mm

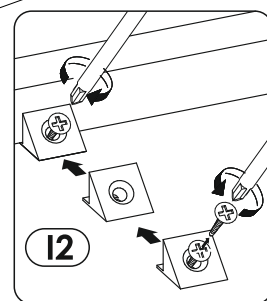
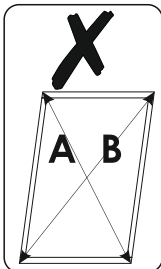
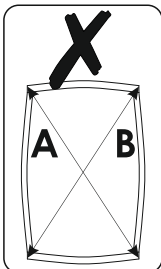
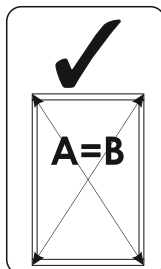
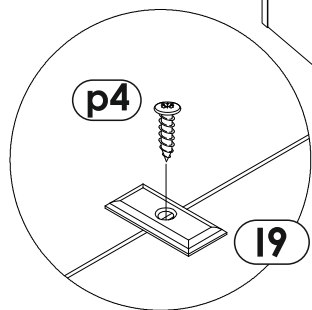
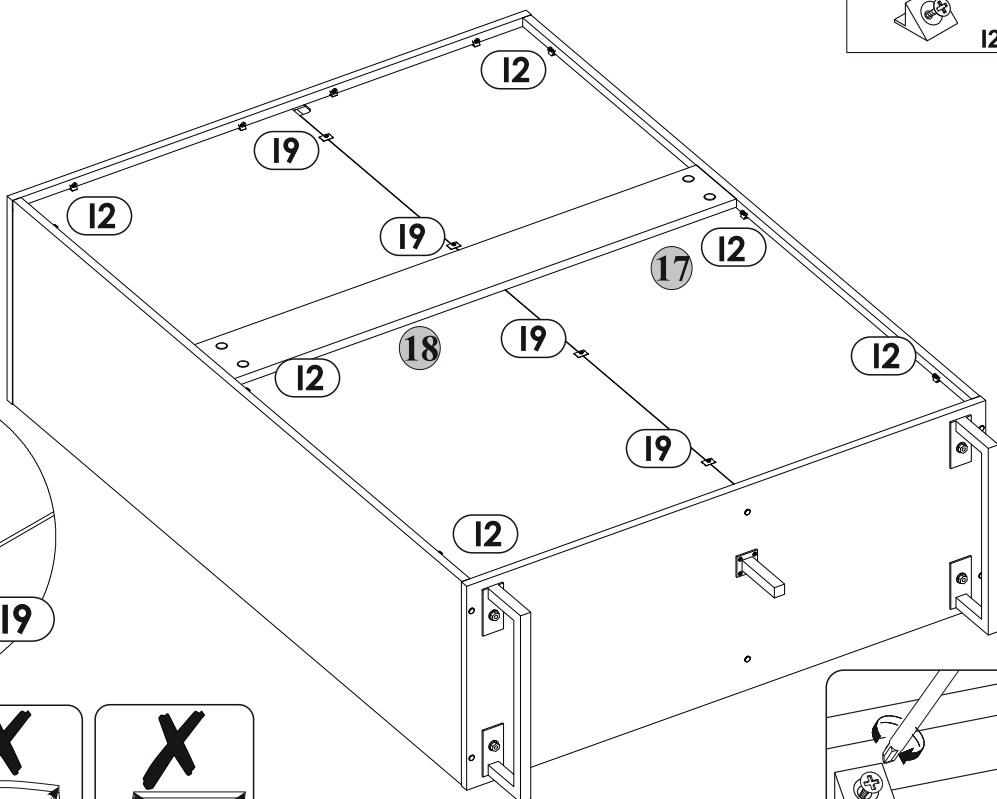

13

20x
φ6x20 mm e23

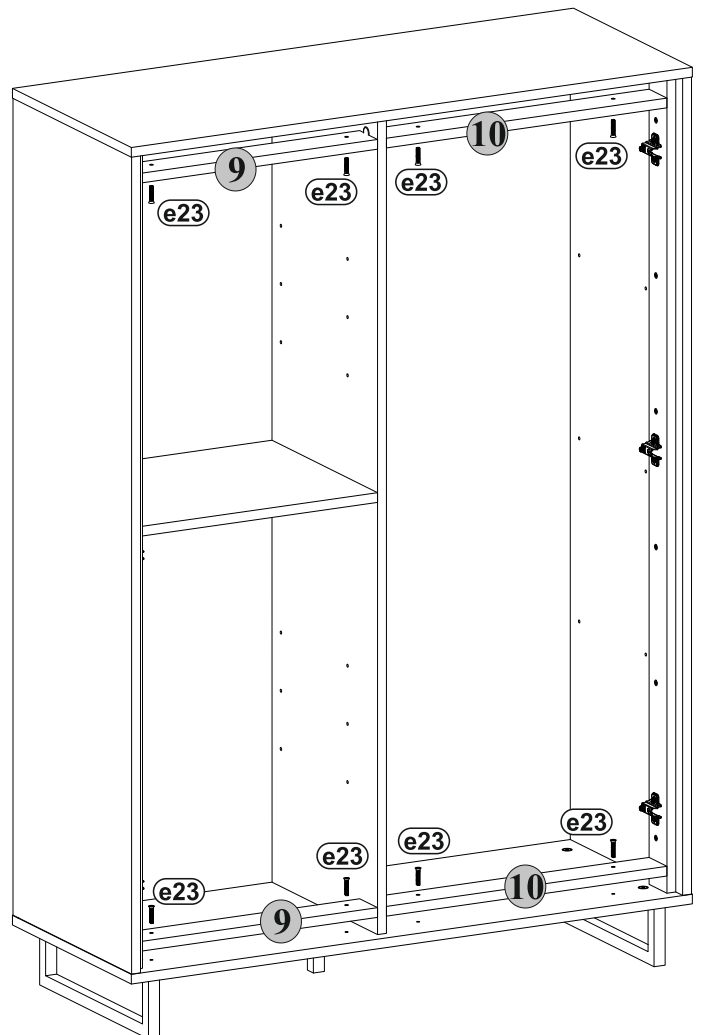
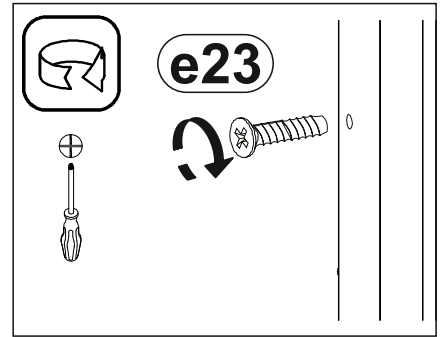
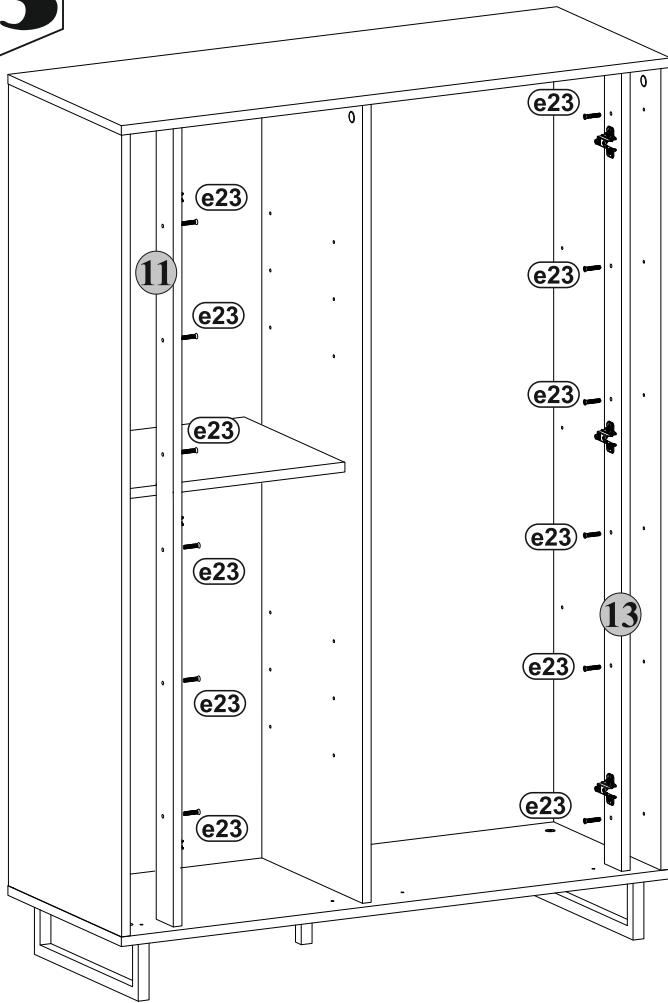

8

I4

4x
p42

2x
c105

1x
t17

1x
n14

2x
φ3.5x16 mm
p1

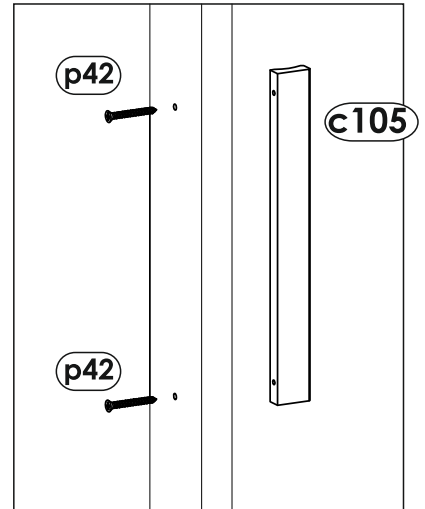
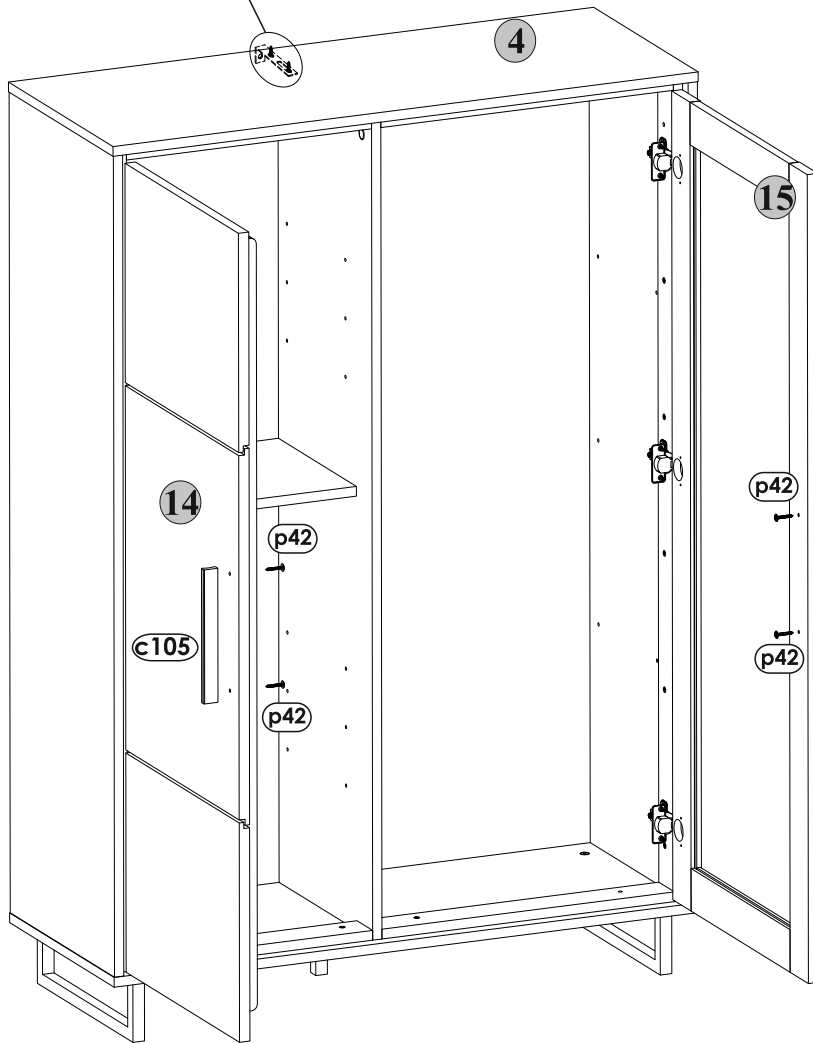
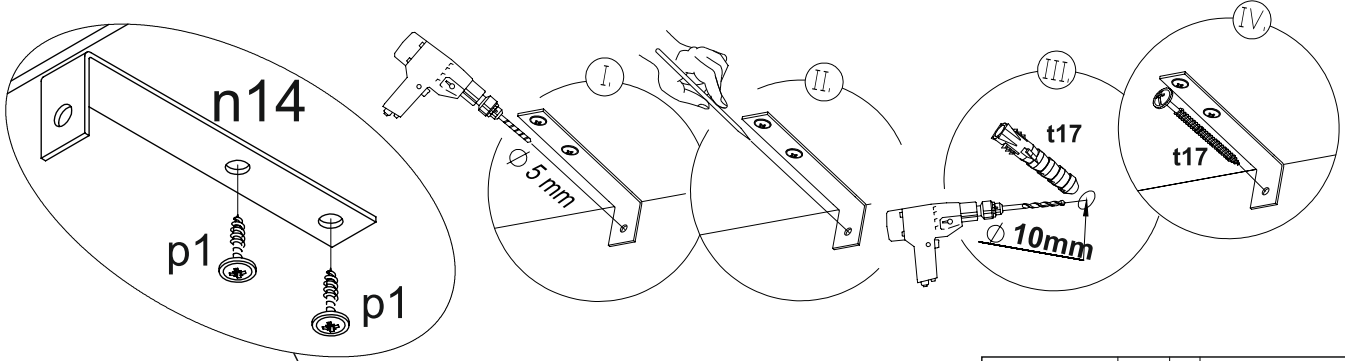

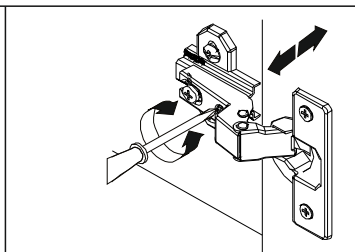
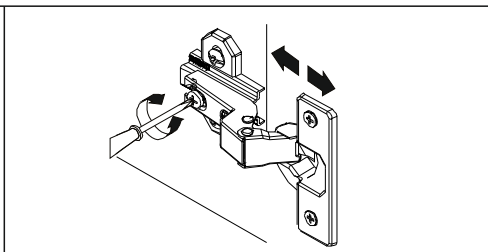
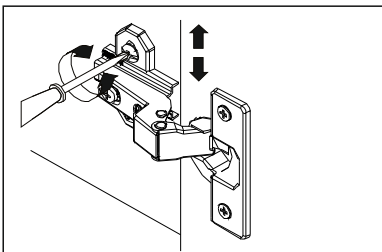
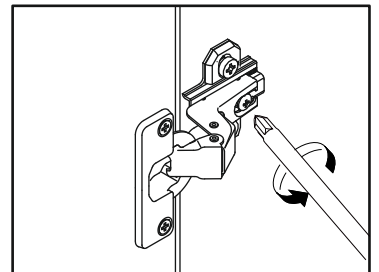
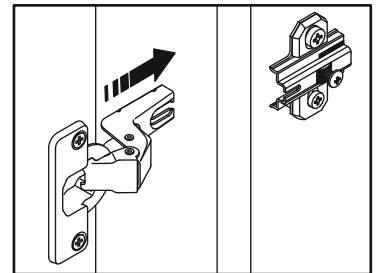

c105



15

12x 
φ5x17 mm d3

8x 
φ5x17 mm d1

14x 
s2

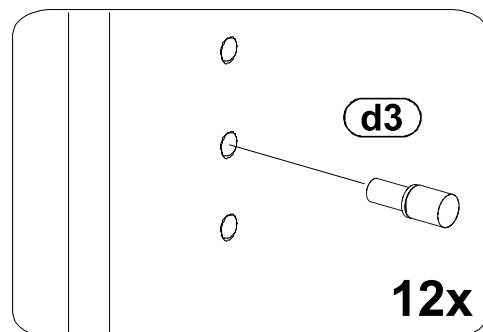
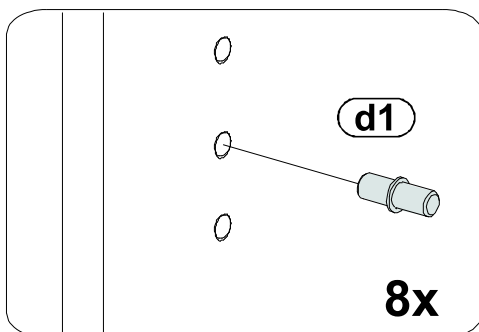
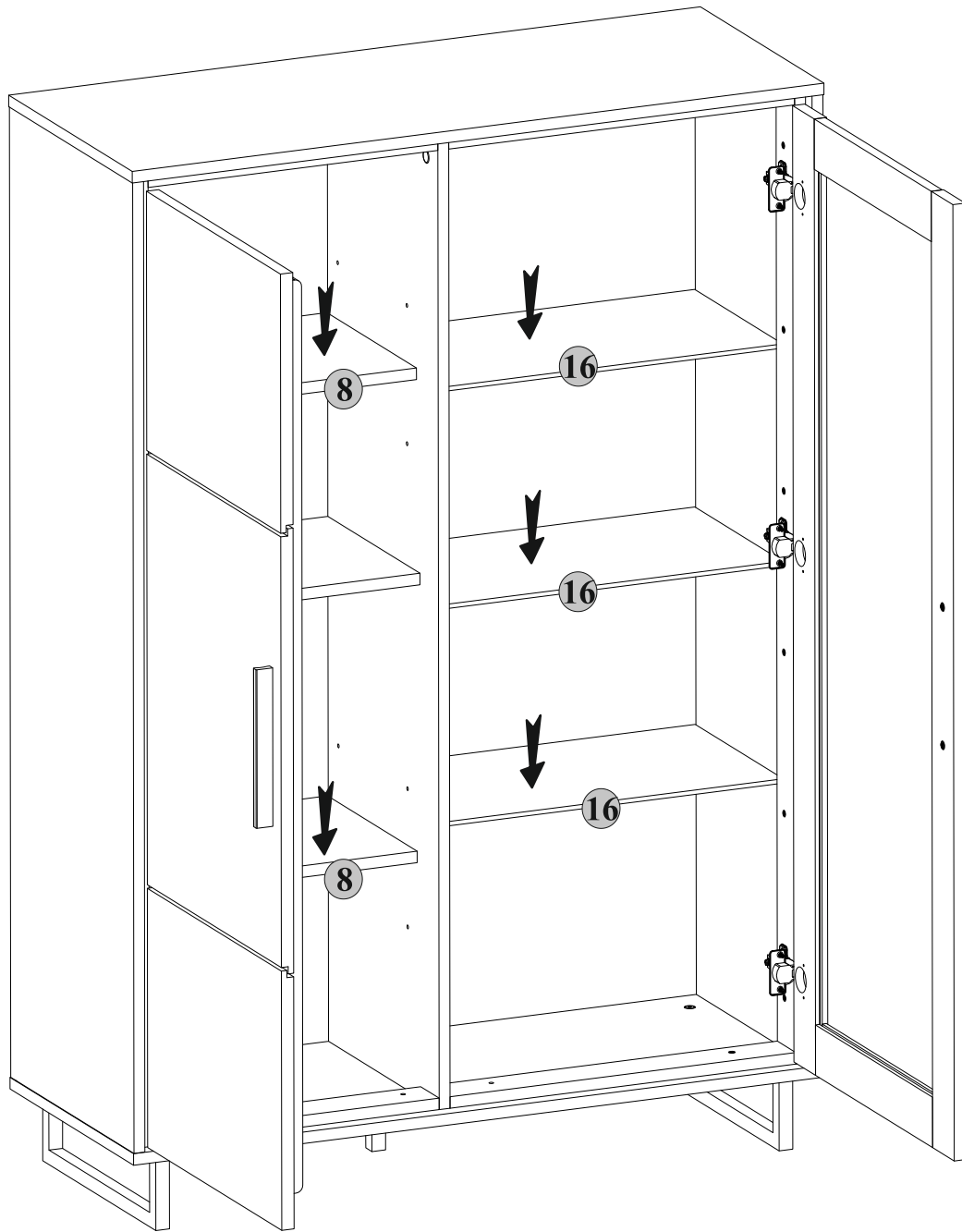

10