

13450234...
 2427022.../54
 2427020.../54
 2427019.../54
 5107929
 5107930
 5107931
 5107932

C

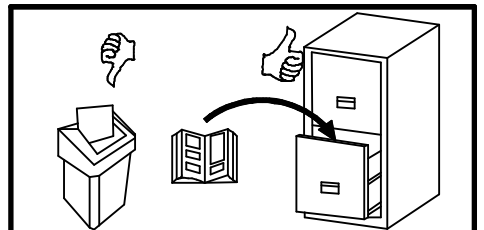

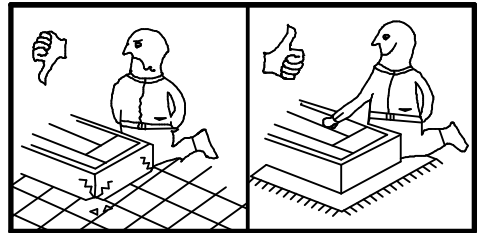
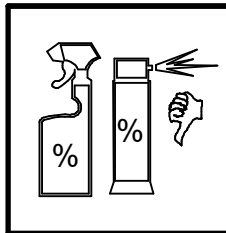
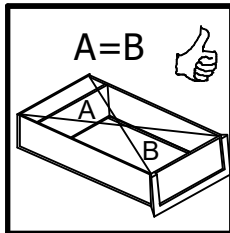
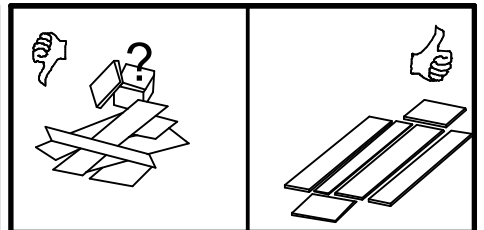
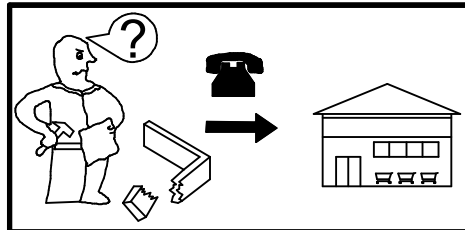
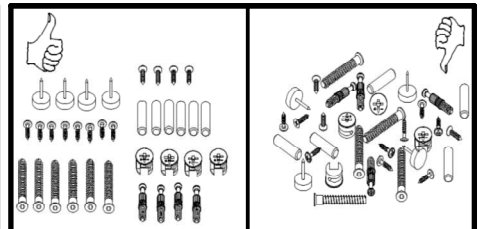
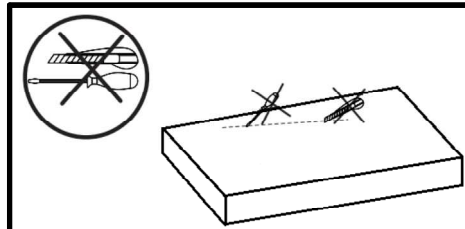
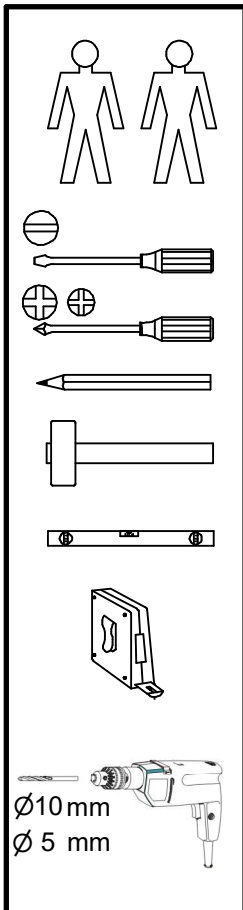
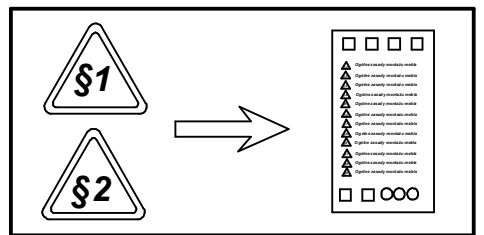
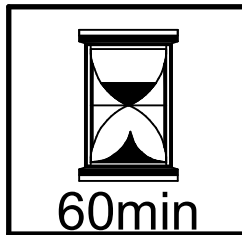
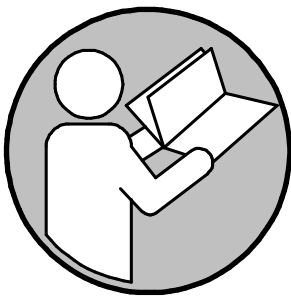
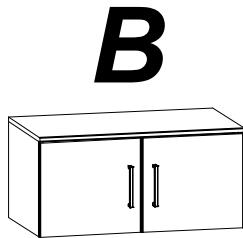
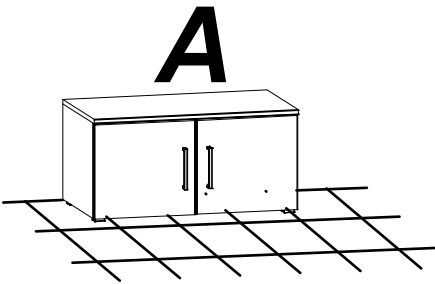
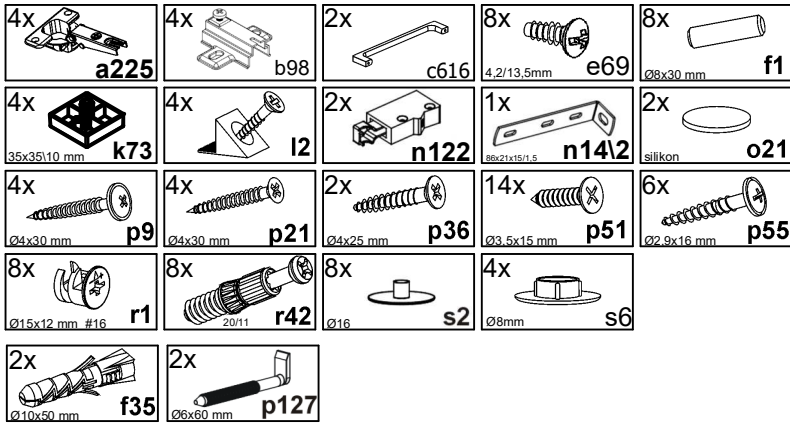

A	B1	B2	C1	C2	C3	D
1	S588-0021	-4	316	346	15	1/1
2	S588-1016	-8	322	382	15	1/1
3	S588-1017	-8	322	382	15	1/1
4	S588-2012	-2	700	400	15	1/1
5	S588-3022	-1	669	360	15	1/1
6	S588-9016	-2	325	679	2,5	1/1

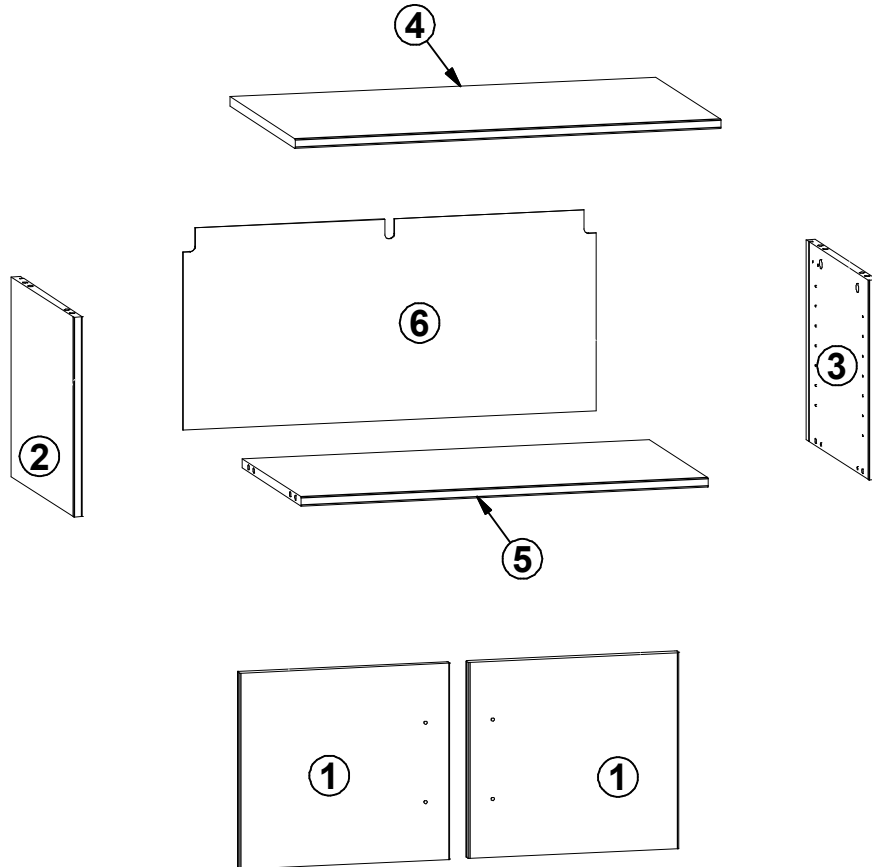

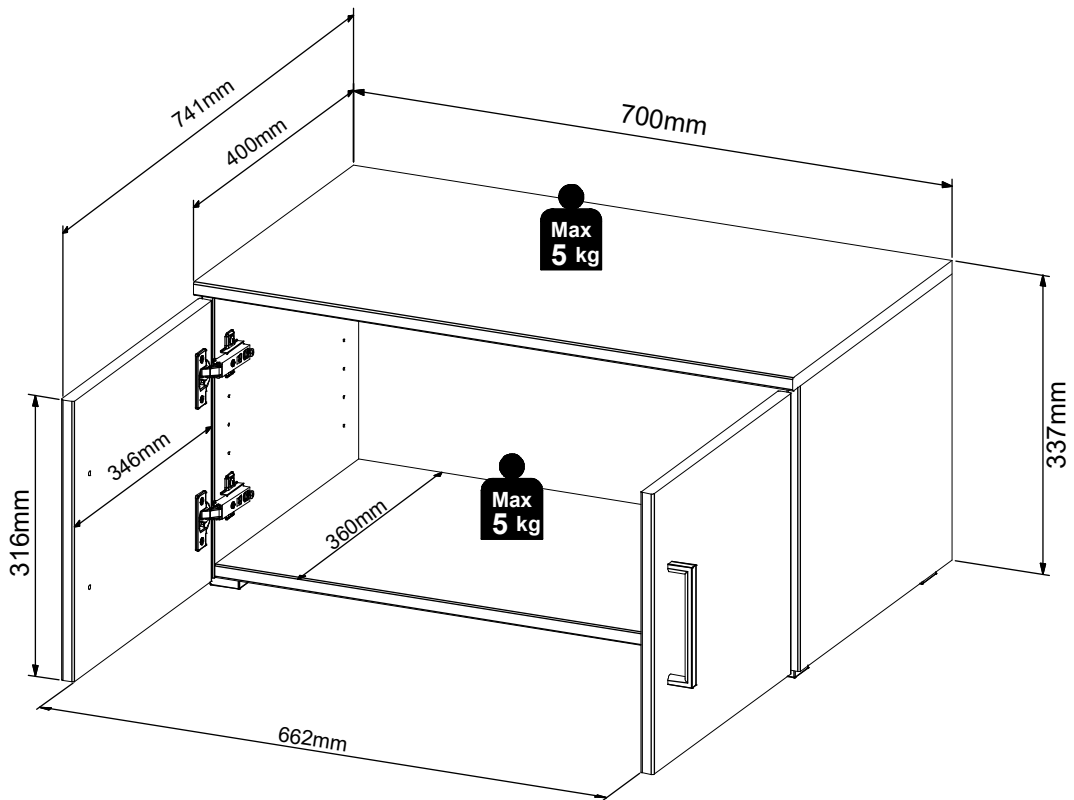

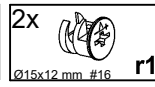
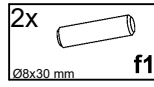
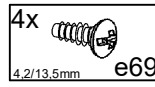
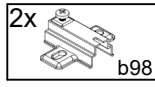
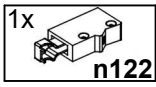
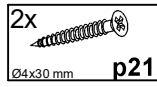
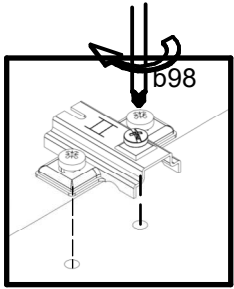

1 ▶

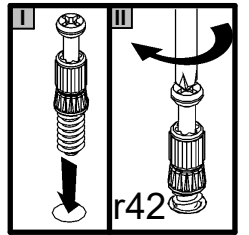
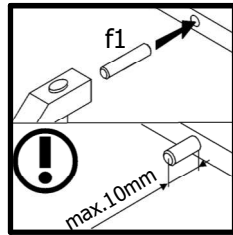
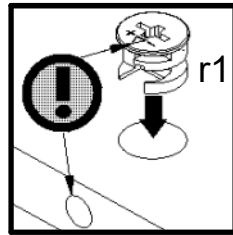
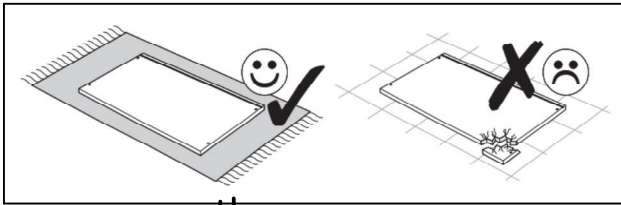
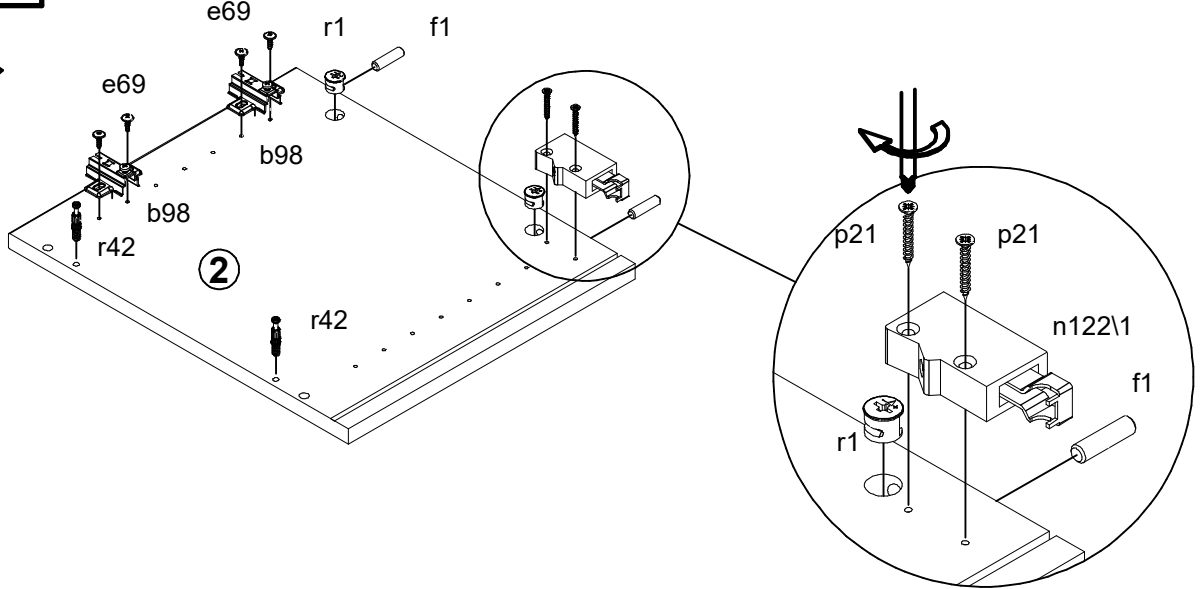

2 ▶

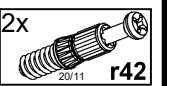
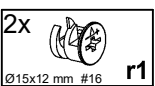
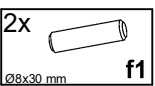
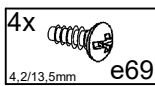
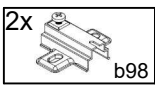
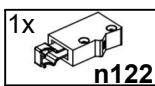
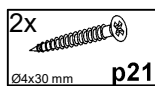
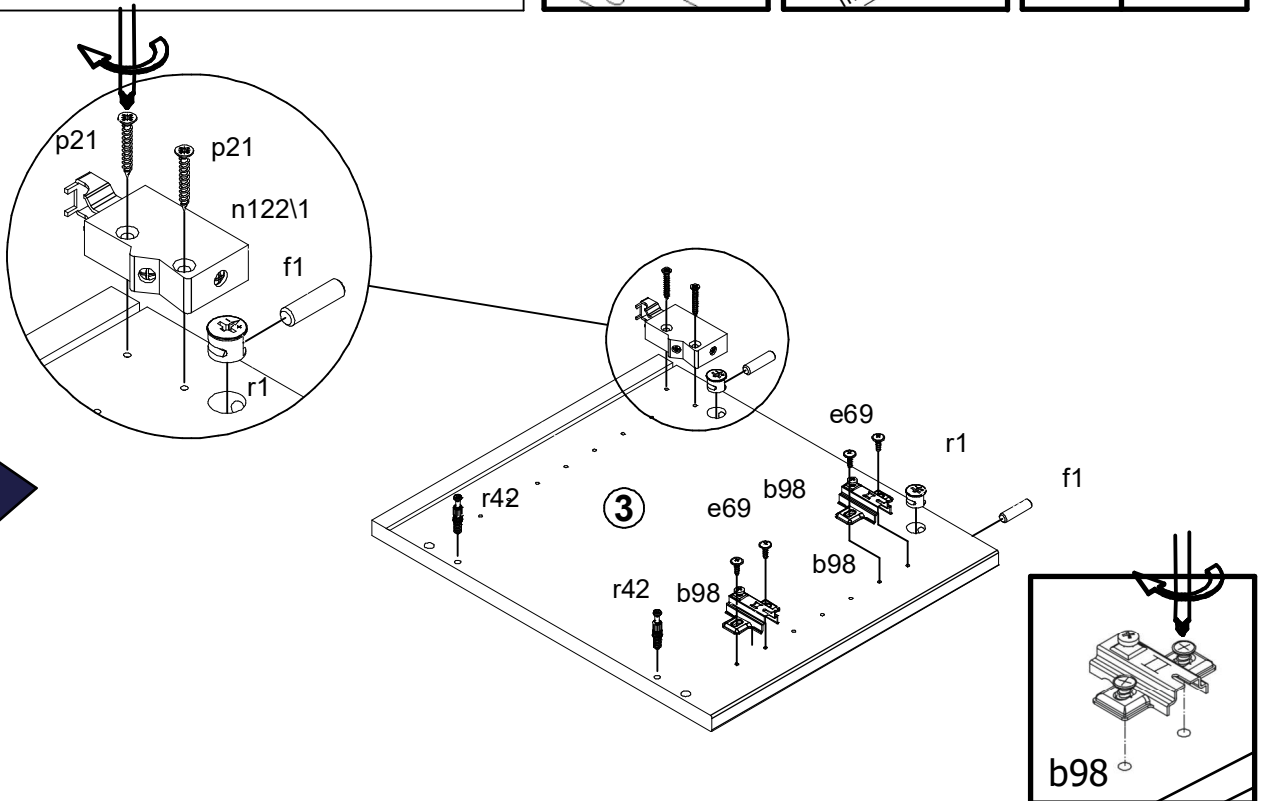

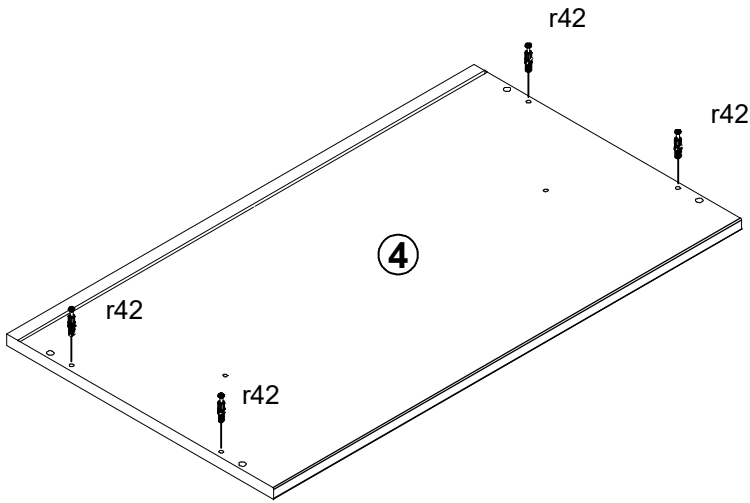

3

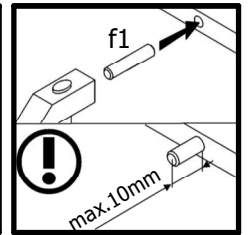
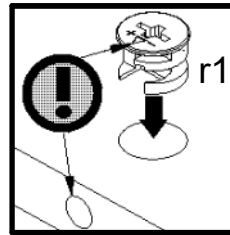
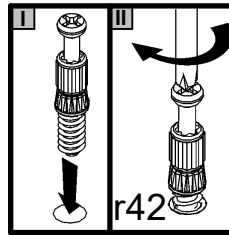
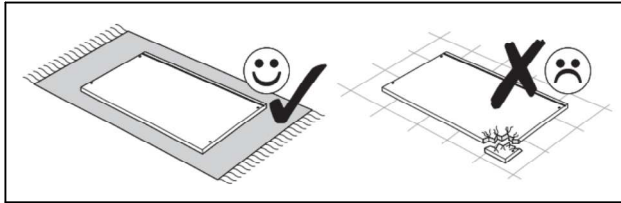

4

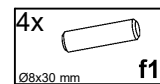
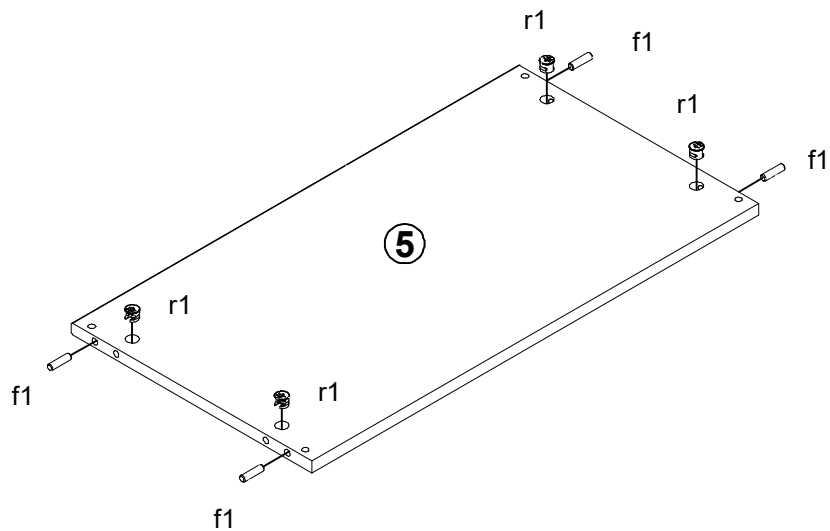

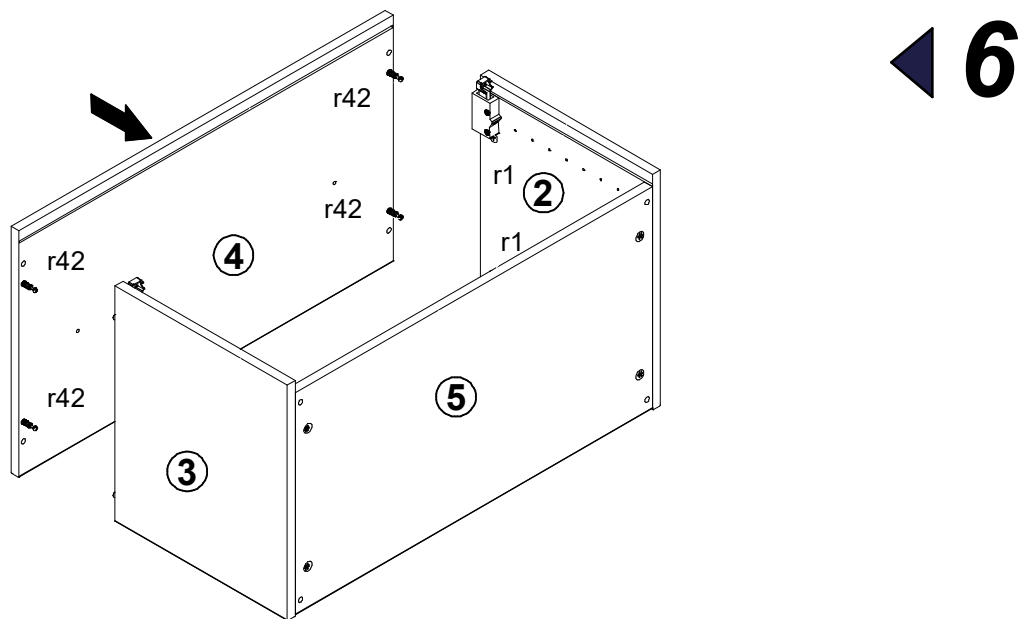
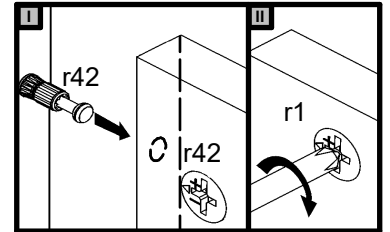
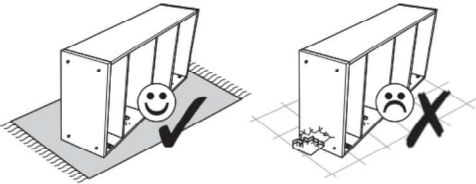
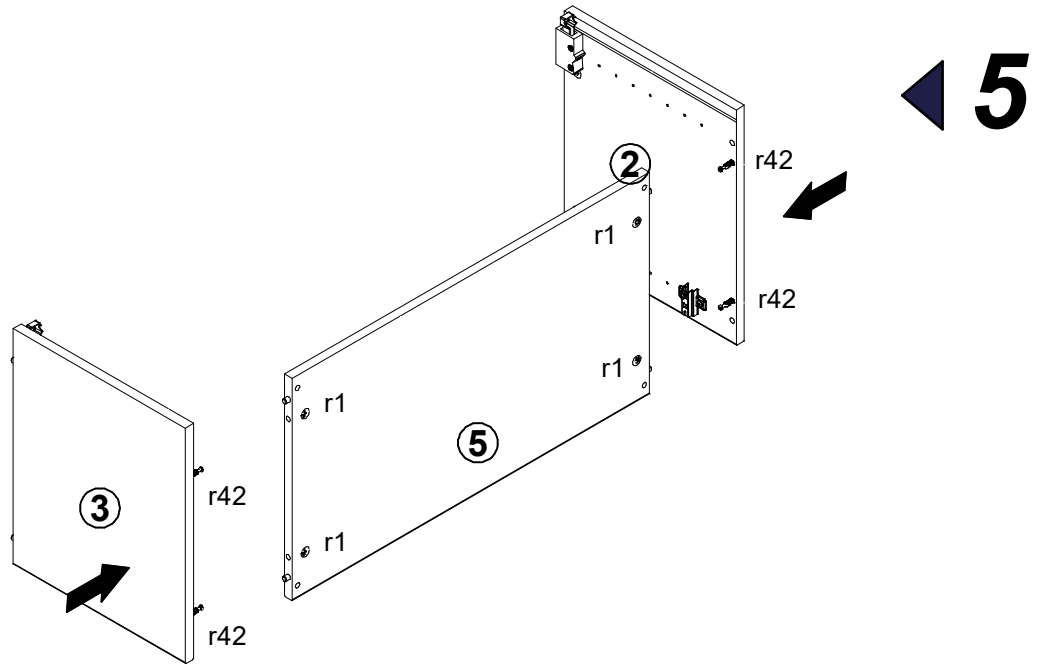

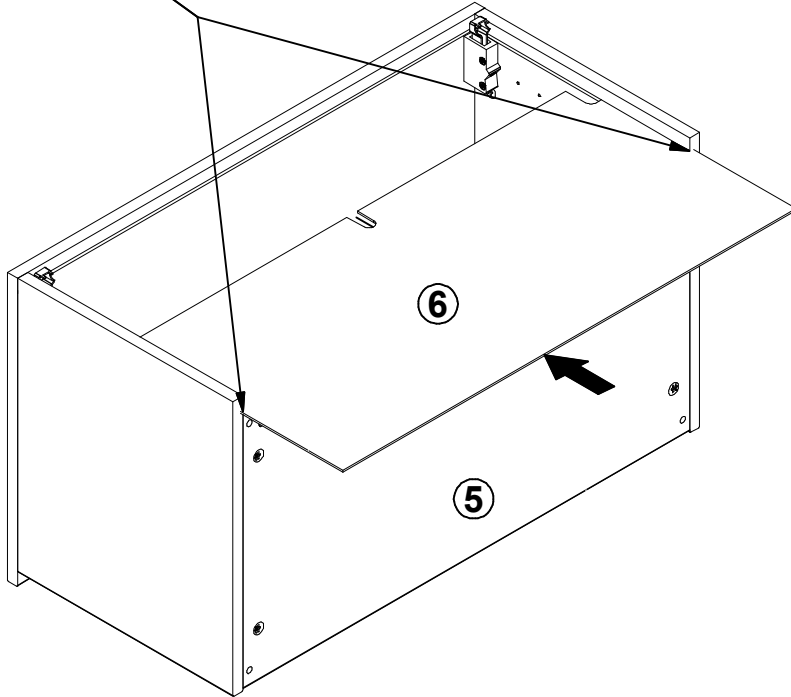
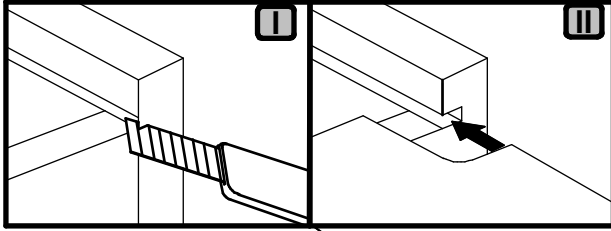

7

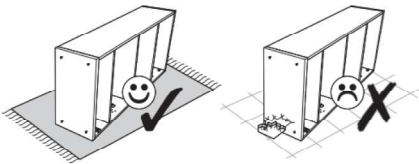

8

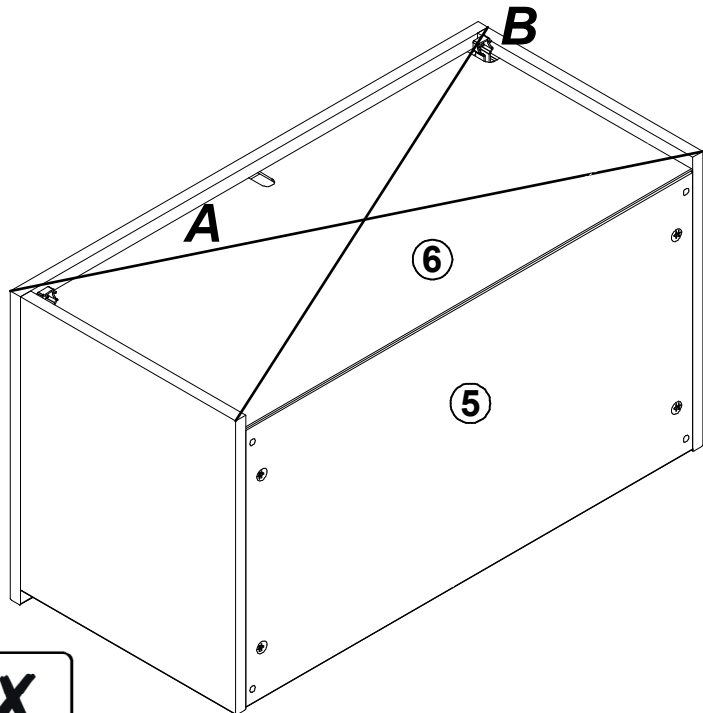

!
A=B

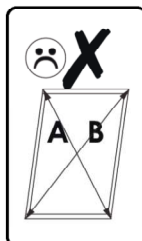
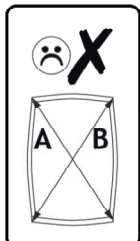
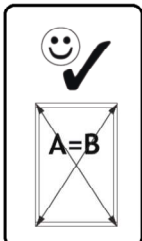

9 ▶

6

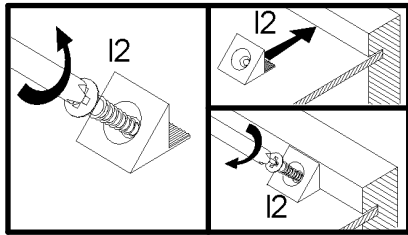
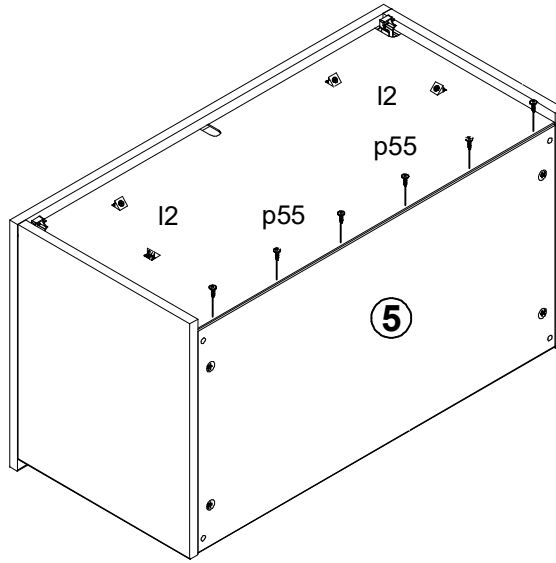
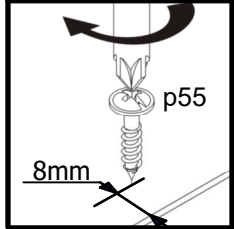

A

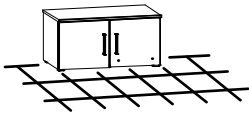

10 ▶

5

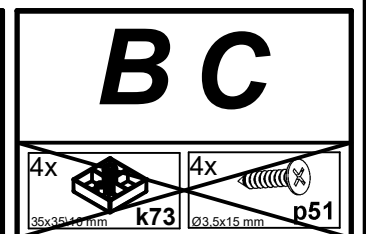
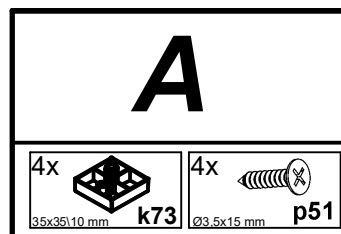
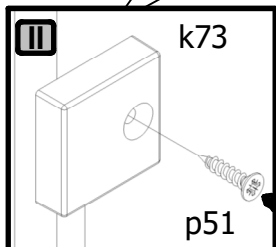
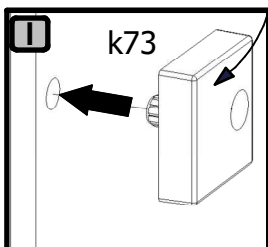
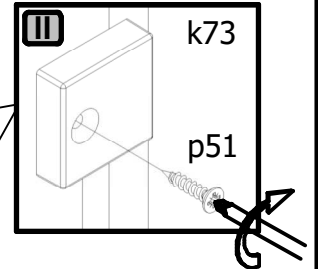
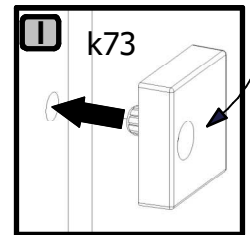

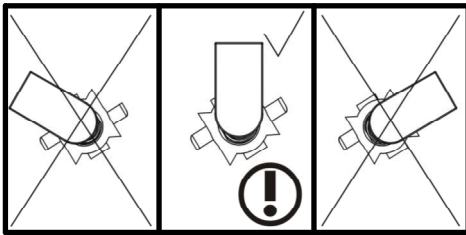
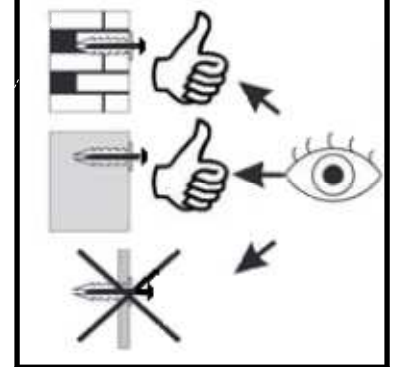
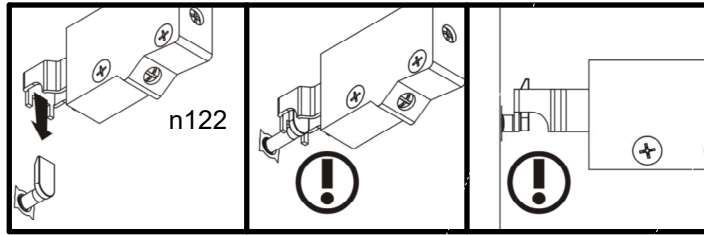
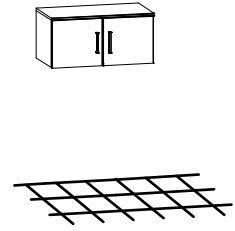
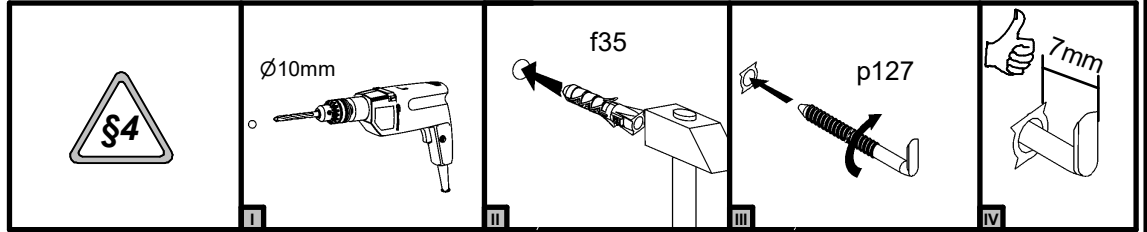

10

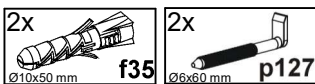
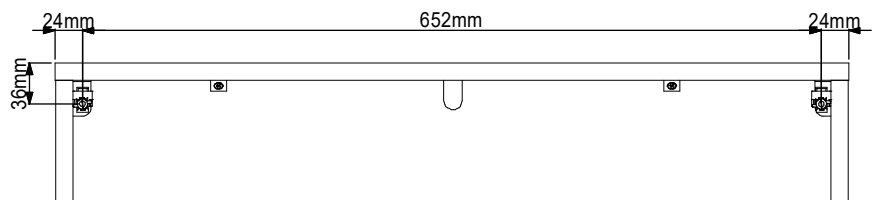
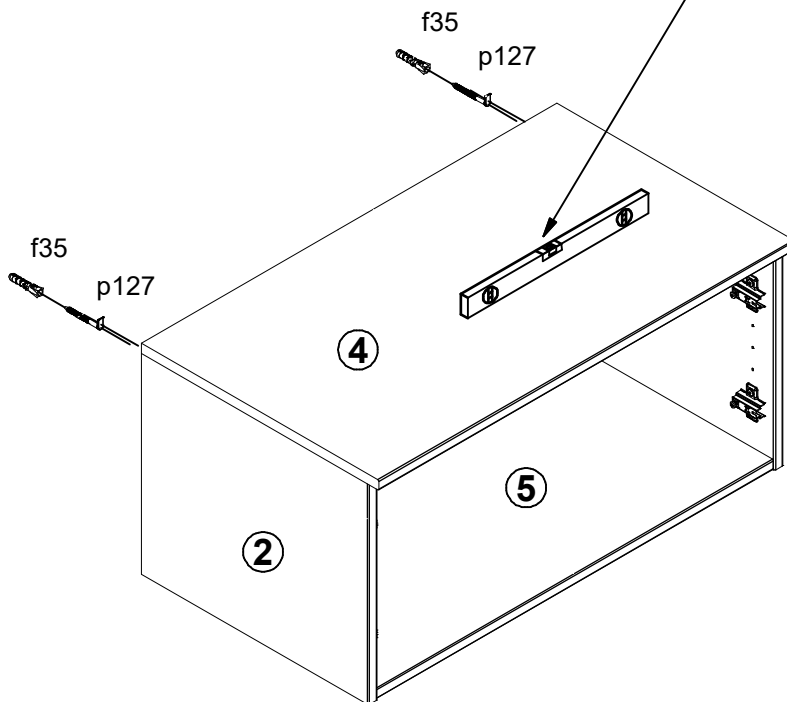
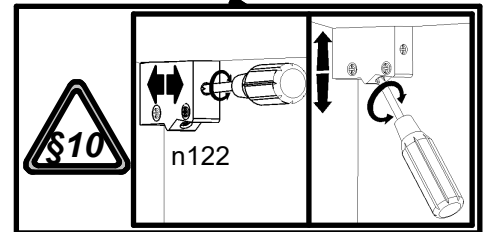

! **B**

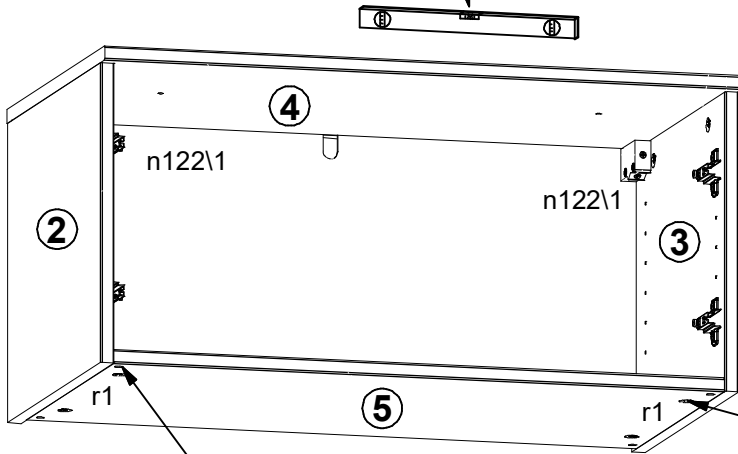
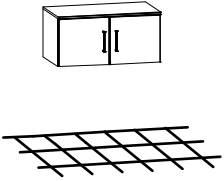
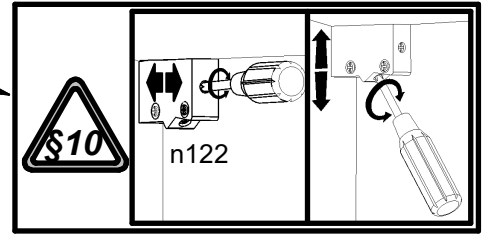
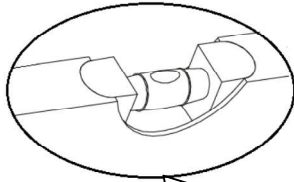
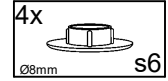

11

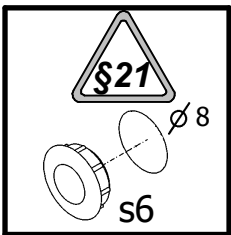
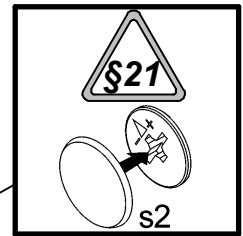

ABC

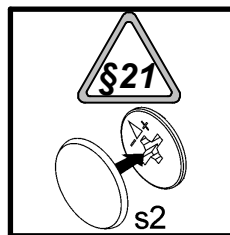

12

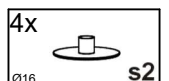
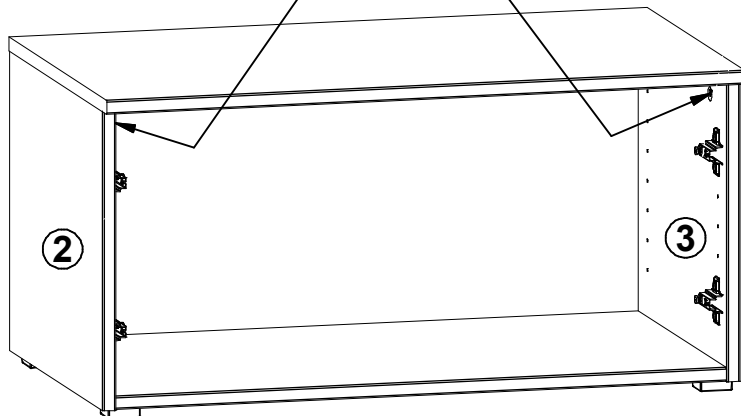

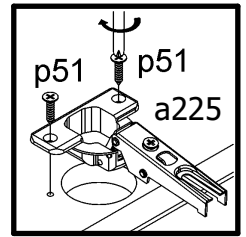
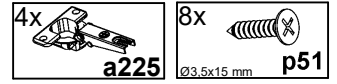
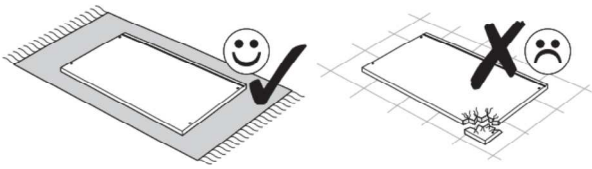

13
2x

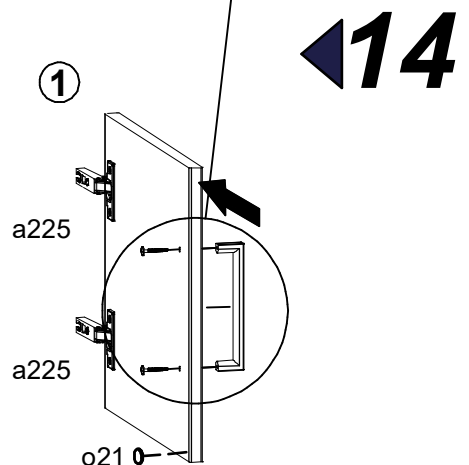
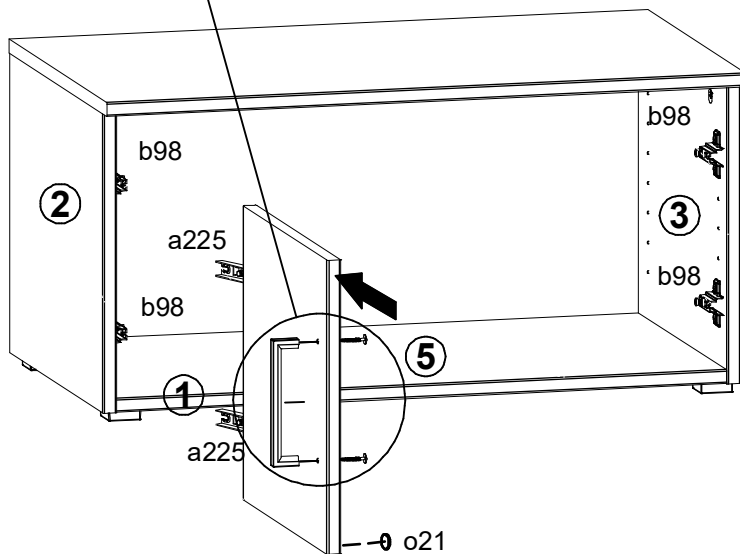
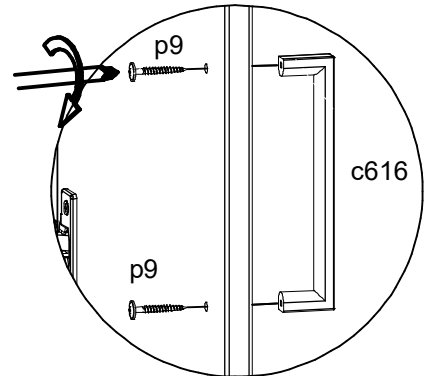
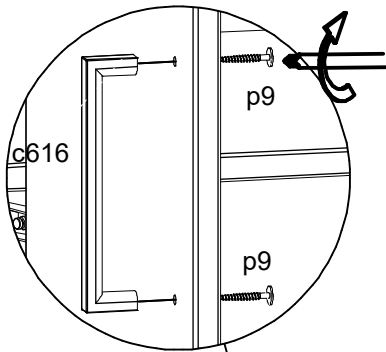
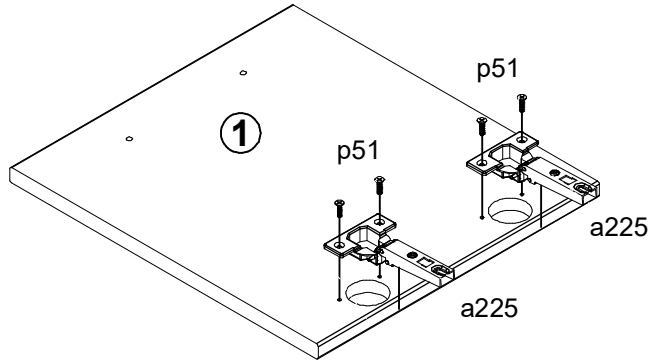

14

